



Operating Instructions **optoNCDT 1420**

ILD 1420-10
ILD 1420-25
ILD 1420-50
ILD 1420-100
ILD 1420-200

ILD 1420-500

ILD 1420-10LL
ILD 1420-25LL
ILD 1420-50LL

ILD 1420-10CL1
ILD 1420-25CL1
ILD 1420-50CL1

Intelligent laser optical displacement measurement

MICRO-EPSILON
MESSTECHNIK
GmbH & Co. KG
Koenigbacher Str. 15

94496 Ortenburg / Germany

Tel. +49 (0) 8542/168-0
Fax +49 (0) 8542/168-90
e-mail info@micro-epsilon.com
www.micro-epsilon.com

Contents

1.	Safety	9
1.1	Symbols Used	9
1.2	Warnings	9
1.3	Notes on CE Marking	10
1.4	Notes on UKCA Marking	11
1.5	Intended Use	11
1.6	Proper Environment	11
2.	Laser Safety	12
2.1	ILD1420 / ILD1420LL	12
2.2	ILD1420 CL1	14
3.	Functional Principle, Technical Data	15
3.1	Short Description	15
3.2	Auto Target Compensation (ATC)	16
3.3	Technical Data ILD1420	17
3.4	Technical Data ILD1420LL	19
3.5	Technical Data ILD1420-CL1	21
4.	Delivery	23
4.1	Unpacking, Included in Delivery	23
4.2	Storage	23
4.3	Structure of the Serial Number	23
5.	Installation	24
5.1	Notes for Operation	24
5.1.1	Reflection Factor of the Target Surface	24
5.1.2	Error Influences	24
5.1.2.1	Light from other Sources	24
5.1.2.2	Color Differences	25
5.1.2.3	Temperature Influences	25
5.1.2.4	Mechanical Vibration	25
5.1.2.5	Movement Blurs	25
5.1.2.6	Surface Roughness	26
5.1.2.7	Angle Influences	27
5.1.3	Optimizing the Measuring Accuracy	28

5.2	Mounting, Dimensions	29
5.3	Indicator Elements at Sensor	31
5.4	Electrical Connections.....	32
5.4.1	Connection Possibilities	32
5.4.2	Pin Assignment.....	34
5.4.3	Supply Voltage	35
5.4.4	Laser on.....	35
5.4.5	Analog Output	36
5.4.6	Multifunctional Input	37
5.4.7	RS422 Connection with USB Converter IF2001/USB.....	37
5.4.8	Digital Output.....	38
5.4.9	Connector and Sensor Cable.....	39
6.	Operation	40
6.1	Getting Ready for Operation	40
6.2	Operation via Web Interface	41
6.2.1	Preconditions.....	41
6.2.2	Access via Web Interface	42
6.2.3	Calibration Protocol.....	43
6.3	Presets, Setups, Measurement Configuration, Signal Quality.....	44
6.3.1	Measurement Presentation via Web Browser.....	46
6.3.2	Video Signal via Web Browser	48
6.4	Programming via ASCII Commands	50
6.5	Timing, Measurement Value Flux	50
7.	Set Sensor Parameter	51
7.1	Preliminary Remarks to the Adjustments	51
7.2	Overview Parameter.....	51
7.3	Inputs	52
7.4	Signal Processing.....	52
7.4.1	Preliminary Remark	52
7.4.2	Measurement Task	53
7.4.3	Measuring Rate	54
7.4.4	Triggering.....	55
7.4.4.1	General.....	55
7.4.4.2	Signal Processing - Trigger for Acquiring Values	57
7.4.4.3	Signal Processing - Value Output Trigger	57
7.4.5	Mask Evaluation Area, ROI.....	58
7.4.6	Peak Selection	59

7.4.7	Error Handling	59
7.4.8	Averaging.....	60
	7.4.8.1 General	60
	7.4.8.2 Moving Average	61
	7.4.8.3 Recursive Average	62
	7.4.8.4 Median.....	62
7.4.9	Zeroing and Mastering	63
	7.4.9.1 Zeroing, Mastering with Select Key	64
	7.4.9.2 Zeroing, Mastering with Hardware Input	65
7.4.10	Data Reduction, Output Data Rate.....	66
7.5	Outputs	67
	7.5.1 Overview	67
	7.5.2 Digital Output, RS422.....	68
	7.5.3 Analog Output Scaling	69
	7.5.3.1 Output Scaling	69
	7.5.3.2 Output Scaling with Key Select.....	70
	7.5.3.3 Output Scaling via Hardware Input.....	71
	7.5.3.4 Calculation of Measuring Value using Analog Current.....	72
	7.5.3.5 Characteristics Distance Value and Analog Output.....	74
	7.5.3.6 Mastering and Teaching Analog Output.....	76
7.6	System Settings.....	77
	7.6.1 General	77
	7.6.2 Unit, Language	77
	7.6.3 Keylock	78
	7.6.4 Load, Save.....	79
	7.6.5 Import, Export.....	81
	7.6.6 Access Authorization.....	82
	7.6.7 Sensor Reset	83
8.	Digital Interfaces RS422	84
8.1	Preliminary Remarks.....	84
8.2	Measurement Data Format	84
8.3	Conversion of the Binary Data Format	85
8.4	Values, Ranges	86
8.5	Characteristics Digital Output.....	88
9.	Cleaning.....	90
10.	Software Support with MEDAQLib	91

11.	Disclaimer	92
12.	Service, Repair	92
13.	Decommissioning, Disposal	93
Appendix		
A 1	Optional Accessories	94
A 2	Factory Setting	98
A 3	ASCII Communication with Sensor	99
A 3.1	General	99
A 3.2	Overview Commands	101
A 3.3	General Commands	104
A 3.3.1	HELP	104
A 3.3.2	GETINFO, Sensor Information	104
A 3.3.3	LANGUAGE, Website	104
A 3.3.4	RESET, Boot Sensor	105
A 3.3.5	RESETCNT, Reset Counter	105
A 3.3.6	ECHO, Switching the Command Reply, ASCII Interface	105
A 3.3.7	PRINT, Sensor Settings	106
A 3.3.8	User Level	107
A 3.3.8.1	LOGIN, Change of the User Level	107
A 3.3.8.2	LOGOUT, Change into User Level	107
A 3.3.8.3	GETUSERLEVEL, User Level Request	107
A 3.3.8.4	STDUSER, Set Standard User	107
A 3.3.8.5	PASSWD, Change Password	107
A 3.3.9	Triggering	108
A 3.3.9.1	TRIGGER, Selection	108
A 3.3.9.2	TRIGGERAT, Effect of the Trigger Input	108
A 3.3.9.3	MFILELEVEL, Input Pulse Multifunctional Input	108
A 3.3.9.4	TRIGGERCOUNT, Number of Displayed Measurement Values	108
A 3.3.9.5	TRIGGERSW, Software Trigger Pulse	109
A 3.3.10	Interfaces	109
A 3.3.10.1	BAUDRATE, RS422	109
A 3.3.10.2	UNIT, Web Interface	109
A 3.3.10.3	MFIFUNC, Function Selection Multifunctional Input	109
A 3.3.10.4	ERROROUT1, Activate Digital Output	109
A 3.3.10.5	ERRORLEVELOUT1, Output Level Digital Output	110
A 3.3.10.6	ERRORLIMIT	110

	A 3.3.10.7 ERRORHYSTERESIS	110
	A 3.3.10.8 ERROROUTHOLD	110
A 3.3.11	Handling of Setups.....	111
	A 3.3.11.1 IMPORT	111
	A 3.3.11.2 MEASSETTINGS, Load / Save Measurement Settings.....	111
	A 3.3.11.3 BASICSETTINGS, Load / Save Device Settings.....	112
	A 3.3.11.4 SETDEFAULT, Default Settings	112
A 3.3.12	ANALOGSCALE, Scaling the Analog Output.....	112
A 3.3.13	Key Function.....	113
	A 3.3.13.1 KEYFUNC, Choose Key Function	113
	A 3.3.13.2 KEYLOCK, Set Keylock.....	113
A 3.4	Measurement.....	113
	A 3.4.1 TARGETMODE, Measurement Mode.....	113
	A 3.4.2 MEASPEAK, Choice of the Peak in the Video Signal	113
	A 3.4.3 MEASRATE, Measuring Rate	114
	A 3.4.4 LASERPOW, Laser Power	114
	A 3.4.5 ROI, Video Signal, Masking the Region of Interest (ROI)	114
	A 3.4.6 Measurement Value Processing.....	114
	A 3.4.6.1 AVERAGE, Measurement Value.....	114
	A 3.4.6.2 MASTERMV, Mastering / Zeroing.....	115
A 3.5	Data Output.....	115
	A 3.5.1 OUTPUT, Selection of Measurement Value Output	115
	A 3.5.2 OUTREDUCEDEVICE, Output Reduction of Measurement Value Output	115
	A 3.5.3 OUTREDUCECOUNT, Output Data Rate	115
	A 3.5.4 OUTHOLD, Error Processing	116
	A 3.5.5 Selection of Measurement Values to be Output	116
	A 3.5.5.1 GETOUTINFO_RS422, Request Data Selection.....	116
	A 3.5.5.2 OUTADD_RS422, Selection of Data Additional Values	116
	A 3.5.5.3 OUTVIDEO_RS422, Adjust Video Output.....	116
A 3.6	Example Command Sequence During Selection of Measurement Value.....	117
A 3.7	Error Messages.....	117
A 4	Control Menu	119
A 4.1	Tab Home.....	119
A 4.2	Tab Settings	120
	A 4.2.1 Inputs.....	120
	A 4.2.2 Signal Processing.....	120
	A 4.2.3 Outputs	122
	A 4.2.4 System Settings.....	124

1. Safety

Sensor operation assumes knowledge of the operating instructions.

1.1 Symbols Used

The following symbols are used in these operating instructions:



Indicates a hazardous situation which, if not avoided, may result in minor or moderate injury.



Indicates a situation that may result in property damage if not avoided.



Indicates a user action.



Indicates a tip for users.

Measure

Indicates hardware or a software button/menu.

1.2 Warnings

Avoid unnecessary laser radiation to be exposed to the human body.

 Switch off the sensor for cleaning and maintenance.

 Switch off the sensor for system maintenance and repair if the sensor is integrated into a system.

Caution - use of controls or adjustments or performance of procedures other than those specified may cause harm.



Connect the power supply and the display/output device according to the safety regulations for electrical equipment.

> Risk of injury

> Damage to or destruction of the sensor

NOTICE

Avoid shocks and impacts to the sensor.
> Damage to or destruction of the sensor

Mount the sensor only to the existing holes on a flat surface. Clamps of any kind are not permitted.
> Damage to or destruction of the sensor

The supply voltage must not exceed the specified limits.
> Damage to or destruction of the sensor

Protect the sensor cable against damage. Attach the cable load-free, hold the cable after appr. 25 cm and hold the pigtail on the connector e.g. zip tie.
> Destruction of the sensor
> Failure of the measuring device

Avoid constant exposure of sensor to splashes of water.
> Damage to or destruction of the sensor

Avoid exposure of sensor to aggressive media (detergents, cooling emulsions).
> Damage to or destruction of the sensor

1.3 Notes on CE Marking

The following apply to the optoNCDT 1420:

- EU directive 2014/30/EU
- EU directive 2011/65/EU

Products which carry the CE mark satisfy the requirements of the EU directives cited and the relevant applicable harmonized European standards (EN). The measuring system is designed for use in industrial environments.

The EU Declaration of Conformity and the technical documentation are available to the responsible authorities according to EU Directives.

1.4 Notes on UKCA Marking

The following apply to the optoNCDT 1220:

- SI 2016 No. 1091:2016-11-16 The Electromagnetic Compatibility Regulations 2016
- SI 2012 No. 3032:2012-12-07 The Restriction of the Use of Certain Hazardous Substances in Electrical and Electronic Equipment Regulations 2012

Products which carry the UKCA mark satisfy the requirements of the directives cited and the relevant applicable standards. The sensor is designed for use in industrial environments.

The UKCA Declaration of Conformity and the technical documentation are available to the responsible authorities according to the UKCA Directives.

1.5 Intended Use

- The optoNCDT 1420 system is designed for use in industrial and laboratory applications.
- It is used for
 - measuring displacement, distance, position and thickness
 - in-process quality control and dimensional testing
- The sensor must only be operated within the limits specified in the technical data, [see 3.3](#).
- The sensor must be used in such a way that no persons are endangered or machines and other material goods are damaged in the event of malfunction or total failure of the controller.
- Take additional precautions for safety and damage prevention in case of safety-related applications.

1.6 Proper Environment

- Protection class: IP67 (applies only when the sensor cable is plugged in)

Lenses are excluded from protection class. Contamination of the lenses leads to impairment or failure of the function.

- Temperature range
 - Operation: 0 °C ... +50 °C (+32 ... +104 °F)
 - Storage: -20 °C ... +70 °C (-4 ... +158 °F)
- Humidity: 5 ... 95 % RH (non-condensing)
- Ambient pressure: Atmospheric pressure

i The protection class is limited to water (no penetrating liquids, detergents or similar aggressive media).

2. Laser Safety

2.1 ILD1420 / ILD1420LL

The optoNCDT 1420 / 1420LL operates with a semiconductor laser with a wavelength of 670 nm (visible/red). The sensors fall within laser class 2. The laser is operated on a pulsed mode, the maximum optical power is ≤ 1 mW. The pulse frequency depends on the adjusted measuring rate (0.25 ... 8 kHz). The pulse duration of the peaks is regulated depending on the measuring rate and reflectivity of the target and can be 0.3 ... 3999.6 μ s.



Laser radiation. Irritation or injury of the eyes possible. Close your eyes or immediately turn away if the laser beam hits the eye.

i

Observe the national laser protection regulations.

Although the laser output is low, directly looking into the laser beam must be avoided. Close your eyes or immediately turn away if the laser beam hits the eye.

Lasers of Class 2 are not subject to notification and a laser protection officer is not required.

The following warning labels are attached to the sensor cable.



Fig. 1 Laser labels on the sensor cable



Fig. 2 Laser warning sign on the sensor housing

During operation of the sensor, the pertinent regulations according to IEC 60825-1 on „Safety of laser products“ must be fully observed at all times. The sensor complies with all applicable laws for the manufacturer of laser devices.

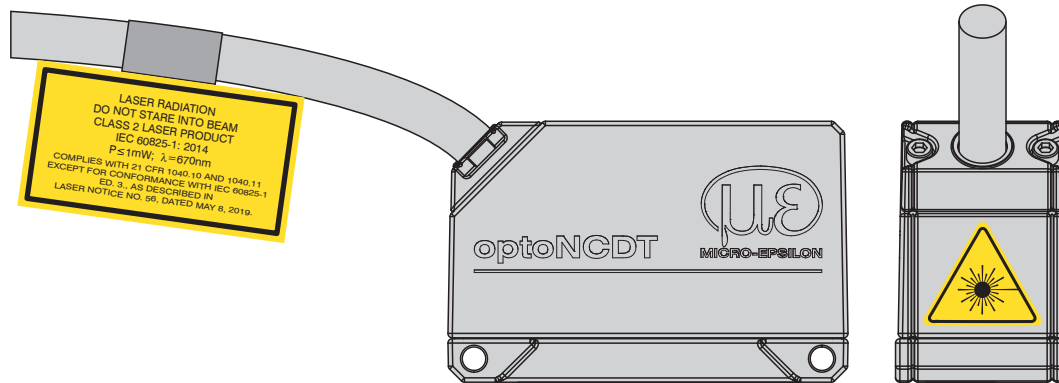

Fig. 3 Sensor cable and sensor with laser sign

i If both warning labels are covered over when the unit is installed, the user must ensure that supplementary labels are applied.

Operation of the laser is indicated visually by the LED on the sensor, [see 5.3](#).

The housing of the optical sensors may only be opened by the manufacturer, [see 11](#).

For repair and service purposes, the sensors must always be sent to the manufacturer.

Please observe national regulations, e. g., Laser Notice No. 50 for the USA.

2.2 ILD1420 CL1

The optoNCDT 1420 CL1 operates with a semiconductor laser with a wavelength of 670 nm (visible/red). The maximum optical power is ≤ 0.39 mW. The sensors fall within laser class 1.

The accessible radiation is harmless under predictable conditions. For class 1 laser devices, impairment of color vision and disturbances, e.g., from a glare effect, cannot be excluded.

Consequently, you can use Class 1 laser equipment without further protective measures.

Lasers of Class 1 are not subject to notification and a laser protection officer is not required.

The following warning labels must be attached to the cover (front and/or rear side) of the sensor housing. The laser warning labels for Germany have already been attached. For other non German speaking countries, an IEC standard label is included in delivery and the versions valid for the user's country must be attached before the device is put into operation for the first time.

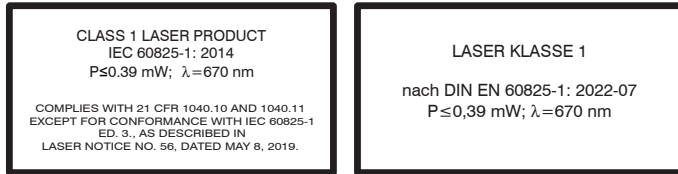

Fig. 4 Laser labels on the sensor cable



Fig. 5 Laser warning sign on the sensor housing

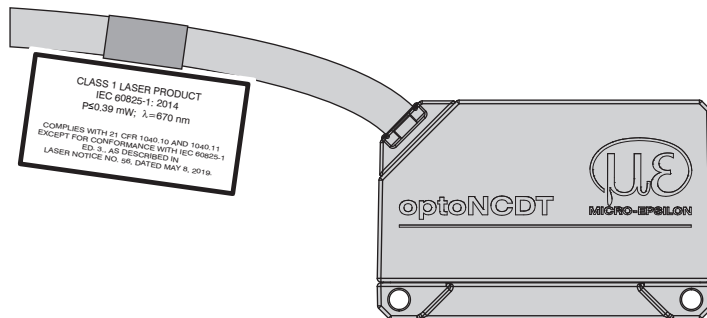
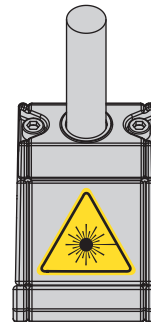

Fig. 6 Sensor cable and sensor with laser sign

optoNCDT 1420



Laser operation is indicated by LED, [see 5.3](#). The housing of the optical sensors may only be opened by the manufacturer, [see 11](#). For repair and service purposes, the sensors must always be sent to the manufacturer.

3. Functional Principle, Technical Data

3.1 Short Description

The optoNCDT 1420 uses the principle of optical triangulation, that is, a visible, modulated point of light is projected onto the target surface.

The diffuse part of the reflection of this point of light is displayed depending on distance on a position-resolving element (CMOS) by an receiver optic which is arranged to the optical axis of the laser beam in a defined angle.

A signal processor in the sensor calculates the distance of the point of light on the measuring object to the sensor by means of the output signal of the CMOS elements. The distance value is linearized and output by means of the analog or RS422 interface.

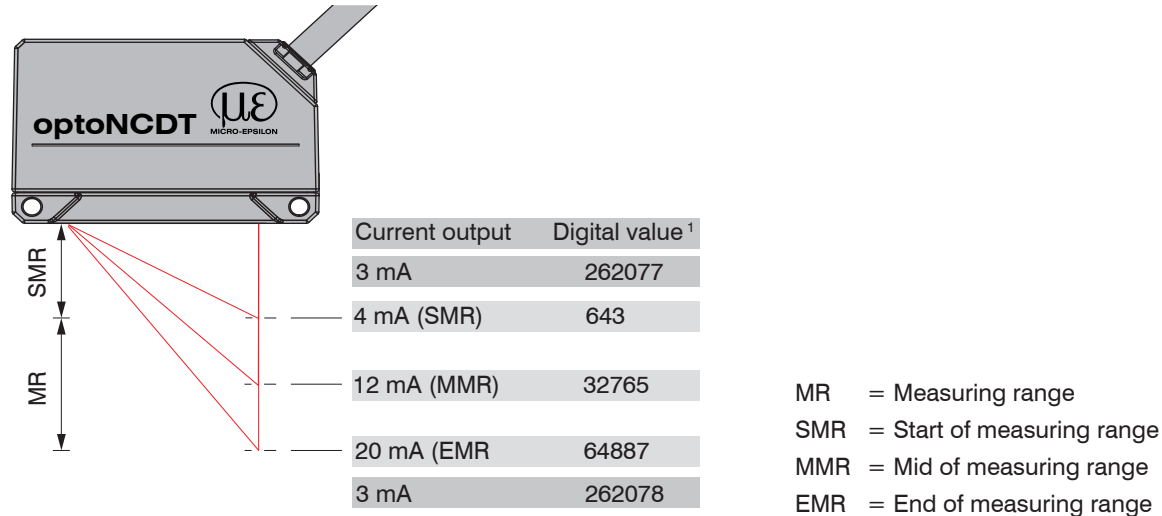

Fig. 7 Definition of terms

1) For distance values without zero setting or mastering only

3.2 Auto Target Compensation (ATC)

The Auto Target Compensation (ATC) enables stable compensation independent of color and brightness of the measuring object. Also small objects can be detected reliably thanks to the small measuring spot.

3.3 Technical Data ILD1420

Model	ILD1420-10	ILD1420-25	ILD1420-50	ILD1420-100	ILD1420-200	ILD1420-500
Measuring range	10 mm	25 mm	50 mm	100 mm	200 mm	500 mm
Start of measuring range	20 mm	25 mm	35 mm	50 mm	60 mm	100 mm
Mid of measuring range	25 mm	37.5 mm	60 mm	100 mm	160 mm	350 mm
End of measuring range	30 mm	50 mm	85 mm	150 mm	260 mm	600 mm
Measuring rate ¹	6 adjustable stages: 8 kHz / 4 kHz / 2 kHz / 1 kHz / 0.5 kHz / 0.25 kHz					
Linearity ²	≤ ±8 μm	≤ ±20 μm	≤ ±40 μm	≤ ±80 μm	≤ ±160 μm	≤ ±500 μm ... ≤ ±1000 μm
	≤ ±0.08 % FSO					≤ ±0,1 ... 0,2 % FSO
Repeatability ³	0.5 μm	1 μm	2 μm	4 μm	8 μm	20 ... 40 μm
Temperature stability ⁴	±0.015 % FSO/K			±0.01 % FSO/K		
Light spot diameter ⁵ (±10 %)	SMR	90 x 120 μm	100 x 140 μm	90 x 120 μm	750 x 1100 μm	
	MMR	45 x 40 μm	120 x 130 μm	230 x 240 μm		
	EMR	140 x 160 μm	390 x 500 μm	630 x 820 μm		
	smallest ø	45 x 40 μm with 24 mm	55 x 50 μm with 31 mm	70 x 65 μm with 42 mm	-	
Light source	Semiconductor laser < 1 mW, 670 nm (red)					
Laser class	Class 2 in accordance with IEC 60825-1: 2014					
Permissible ambient light ⁶	50,000 lx			30,000 lx	10,000 lx	
Supply voltage	11 ... 30 VDC					
Power consumption	< 2 W (24 V)					
Signal input	1 x HTL laser on/off; 1 x HTL multifunction input: trigger in, zero setting, mastering, teach					
Digital interface ⁷	RS422 (16 bit) / EtherCAT / PROFINET / EtherNet/IP					
Analog output ⁸	4 ... 20 mA / 1 ... 5 V with cable PCF1420-3/U (16 bit; freely scalable within the measuring range)					

Model	ILD1420-10	ILD1420-25	ILD1420-50	ILD1420-100	ILD1420-200	ILD1420-500
Switching output	1 x error output: npn, pnp, push pull					
Connection	integrated cable 3 m, open ends, minimum bending radius 30 mm (fixed installation) or integrated pigtail 0.3 m with 12-pin M12 connector (see accessories for suitable connection cable)					
Mounting	Screw connection via two mounting holes					
Temperature range	Operation					
	Storage					
Shock (DIN EN 60068-2-27)	15 g / 6 ms in 3 axes, 1000 shocks each					
Vibration (DIN EN 60068-2-6)	20 g / 20 ... 500 Hz in 3 axes, 2 directions and 10 cycles each					
Protection class (DIN EN 60529) ⁹	IP67					
Material	Aluminium housing					
Weight	approx. 60 g (incl. pigtail), approx. 145 g (incl. cable)					
Control and display elements ¹⁰	Select button: zero, teach, factory setting; web interface for setup: selectable presets, peak selection, video signal, freely selectable averaging possibilities, data reduction, setup management; 2 x color LEDs for power/status					

[1] Factory setting 2 kHz, modifying the factory setting requires the IF2001/USB converter (see accessories); for models with laser class 1 the maximum measuring rate is 4 kHz

[2] FSO = Full Scale Output; the specified data apply to white, diffuse reflecting surfaces (Micro-Epsilon reference ceramic for ILD sensors)

[3] Measuring rate 2 kHz, median 9

[4] The specified value is only achieved by mounting on a metallic sensor holder. Good heat dissipation from the sensor to the holder must be ensured.

[5] $\pm 10\%$; SMR = Start of measuring range; MMR = Mid of measuring range; EMR = End of measuring range

[6] Illuminant: light bulb

[7] For EtherCAT, PROFINET and EtherNet/IP, connection via interface module is required (see accessories)

[8] For models with laser class 1 the D/A conversion is done with 12 bit

[9] Models with laser class 1 have the protection class IP65

[10] Access to web interface requires connection to PC via IF2001/USB (see accessories)

3.4 Technical Data ILD1420LL

Model		ILD1420-10LL	ILD1420-25LL	ILD1420-50LL
Measuring range		10 mm	25 mm	50 mm
Start of measuring range		20 mm	25 mm	35 mm
Mid of measuring range		25 mm	37.5 mm	60 mm
End of measuring range		30 mm	50 mm	85 mm
Measuring rate ¹		6 adjustable stages: 8 kHz / 4 kHz / 2 kHz / 1 kHz / 0.5 kHz / 0.25 kHz		
Linearity ²		≤ ±8 μm	≤ ±20 μm	≤ ±40 μm
		≤ ±0.08 % FSO		
Repeatability ³		0.5 μm	1 μm	2 μm
Temperature stability ⁴		±0.015 % FSO/K		
Light spot diameter (±10 %) ⁵	SMR	140 x 720 μm	220 x 960 μm	240 x 1250 μm
	MMR	65 x 680 μm	80 x 970 μm	130 x 1450 μm
	EMR	140 x 660 μm	240 x 1000 μm	380 x 1650 μm
	smallest ø	65 x 680 μm with 25 mm	80 x 970 μm with 37.5 mm	110 x 1400 μm with 52.5 mm
Light source		Semiconductor laser < 1 mW, 670 nm (red)		
Laser class		Class 2 in accordance with IEC 60825-1: 2014		
Permissible ambient light ⁶		50,000 lx		
Supply voltage		11 ... 30 VDC		
Power consumption		< 2 W (24 V)		
Signal input		1 x HTL laser on/off; 1 x HTL multifunction input: trigger in, zero setting, mastering, teach		
Digital interface ⁷		RS422 (16 bit) / EtherCAT / PROFINET / EtherNet/IP		
Analog output ⁸		4 ... 20 mA / 1 ... 5 V with cable PCF1420-3/U (16 bit; freely scalable within the measuring range)		

Model	ILD1420-10LL	ILD1420-25LL	ILD1420-50LL
Switching output	1 x error output: npn, pnp, push pull		
Connection	Integrated cable 3 m, open ends, minimum bending radius 30 mm (fixed installation) or integrated pigtail 0.3 m with 12-pin M12 connector (see accessories for suitable connection cable)		
Mounting	Screw connection via two mounting holes		
Temperature range	Operation	0 ... +50 °C (+32 ... +122 °F) (non-condensing)	
	Storage	-20 ... +70 °C (-4 ... +158 °) (non-condensing)	
Shock (DIN EN 60068-2-27)	15 g / 6 ms in 3 axes, 1000 shocks each		
Vibration (DIN EN 60068-2-6)	20 g / 20 ... 500 Hz in 3 axes, 2 directions and 10 cycles each		
Protection class (DIN EN 60529) ⁹	IP67		
Material	Aluminium housing		
Weight	approx. 60 g (incl. pigtail), approx. 145 g (incl. cable)		
Control and display elements ¹⁰	Select button: zero, teach, factory setting; web interface for setup: selectable presets, peak selection, video signal, freely selectable averaging possibilities, data reduction, setup management		

[1] Factory setting 2 kHz, modifying the factory setting requires the IF2001/USB converter (see accessories); for models with laser class 1 the maximum measuring rate is 4 kHz

[2] FSO = Full Scale Output; the specified data apply to white, diffuse reflecting surfaces (Micro-Epsilon reference ceramic for ILD sensors)

[3] Measuring rate 2 kHz, median 9

[4] The specified value is only achieved by mounting on a metallic sensor holder. Good heat dissipation from the sensor to the holder must be ensured.

[5] ±10 %; SMR = Start of measuring range; MMR = Mid of measuring range; EMR = End of measuring range

[6] Illuminant: light bulb

[7] For EtherCAT, PROFINET and EtherNet/IP, connection via interface module is required (see accessories)

[8] For models with laser class 1 the D/A conversion is done with 12 bit

[9] Models with laser class 1 have the protection class IP65

[10] Access to web interface requires connection to PC via IF2001/USB (see accessories)

3.5 Technical Data ILD1420-CL1

Model		ILD1420-10CL1	ILD1420-25CL1	ILD1420-50CL1
Measuring range		10 mm	25 mm	50 mm
Start of measuring range		20 mm	25 mm	35 mm
Mid of measuring range		25 mm	37.5 mm	60 mm
End of measuring range		30 mm	50 mm	85 mm
Measuring rate ¹		5 adjustable stages: 4 kHz / 2 kHz / 1 kHz / 0.5 kHz / 0.25 kHz		
Linearity ²		≤ ±8 μm	≤ ±20 μm	≤ ±40 μm
		≤ ±0.08 % FSO		
Repeatability ³		0.5 μm	1 μm	2 μm
Temperature stability ⁴		± 0.015 % FSO/K		
Light spot diameter (±10 %) ⁵	SMR	90 x 120 μm	100 x 140 μm	90 x 120 μm
	MMR	45 x 40 μm	120 x 130 μm	230 x 240 μm
	EMR	140 x 160 μm	390 x 500 μm	630 x 820 μm
	smallest ø	45 x 40 μm with 24 mm	55 x 50 μm with 31 mm	70 x 65 μm with 42 mm
Light source		Semiconductor laser ≤ 0.39 mW, 670 nm (red)		
Laser class		Class 1 in accordance with IEC 60825-1: 2014		
Permissible ambient light ⁶		15,000 lx		
Supply voltage		11 ... 30 VDC		
Power consumption		< 2 W (24 V)		
Signal input		1 x HTL laser on/off; 1 x HTL multifunction input: trigger in, zero setting, mastering, teach		
Digital interface ⁷		RS422 (16 bit) / EtherCAT / PROFINET / EtherNet/IP		
Analog output		4 ... 20 mA; 1 ... 5 V with cable PCF1420-3/U (12 bit; freely scalable within the measuring range)		

Model	ILD1420-10CL1	ILD1420-25CL1	ILD1420-50CL1
Switching output	1 x error output: npn, pnp, push pull		
Connection	Integrated cable 3 m, open ends, minimum bending radius 30 mm (fixed installation) or integrated pigtail 0.3 m with 12-pin M12 connector (see accessories for suitable connection cable)		
Mounting	Screw connection via two mounting holes		
Temperature range	Operation	0 ... +50 °C (+32 ... +122 °F) (non-condensing)	
	Storage	-20 ... +70 °C (-4 ... +158 °) (non-condensing)	
Shock (DIN EN 60068-2-27)	15 g / 6 ms in 3 axes, 1000 shocks each		
Vibration (DIN EN 60068-2-6)	20 g / 20 ... 500 Hz in 3 axes, 2 directions and 10 cycles each		
Protection class (DIN EN 60529)	IP65		
Material	Aluminium housing		
Weight	approx. 60 g (incl. pigtail), approx. 145 g (incl. cable)		
Control and display elements ⁸	Select button: zero, teach, factory setting; web interface for setup: selectable presets, peak selection, video signal, freely selectable averaging, data reduction, setup management; 2 x color LEDs for power/status		

[1] Factory setting 2 kHz, modifying the factory setting requires the IF2001/USB converter (see accessories);

[2] FSO = Full Scale Output; the specified data apply to white, diffuse reflecting surfaces (Micro-Epsilon reference ceramic for ILD sensors)

[3] Measuring rate 2 kHz, median ⁹

[4] The specified value is only achieved by mounting on a metallic sensor holder. Good heat dissipation from the sensor to the holder must be ensured.

[5] $\pm 10\%$; SMR = Start of measuring range; MMR = Mid of measuring range; EMR = End of measuring range

[6] Illuminant: light bulb

[7] For EtherCAT, PROFINET and EtherNet/IP, connection via interface module is required (see accessories)

[8] Access to web interface requires connection to PC via IF2001/USB (see accessories)

4. Delivery

4.1 Unpacking, Included in Delivery

- 1 Sensor ILD 1420
- 1 Assembly instructions
- 1 Digital calibration protocol, accessible via the web interface
- Accessories (2 pieces screw M2 and 2 pieces washer)

- ▶ Carefully remove the components of the measuring system from the packaging and ensure that the goods are forwarded in such a way that no damage can occur.
- ▶ Check the delivery for completeness and shipping damage immediately after unpacking.
- ▶ If there is damage or parts are missing, immediately contact the manufacturer or supplier.

See Appendix for further accessories, [see A 1](#).

4.2 Storage

Temperature range (storage): -20 ... +70 °C (-4 ... +158 °F)

Humidity: 5 ... 95 % RH (non-condensing)

4.3 Structure of the Serial Number

Sensors in a new design have an extended measuring rate, a higher resolution D/A converter and an improved protection class, see [Chap.3](#). They can be recognized by the serial number with the following structure:

- 10xxxxxx = ILD1420-10, ILD1420-25, ILD1420-50
- 30xxxxxx = ILD1420-10LL, ILD1420-25LL, ILD1420-50LL
- 40xxxxxx = ILD1420-100, ILD1420-200, ILD1420-500

Serial numbers for sensors with the old design can be recognized by the following structure:
JJMMxxxx (J = year, M = month)

5. Installation

5.1 Notes for Operation

5.1.1 Reflection Factor of the Target Surface

In principle the sensor evaluates the diffuse part of the reflected laser light.

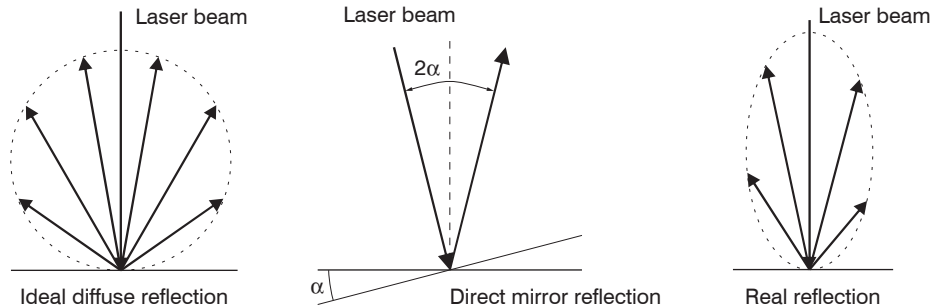

Fig. 8 Reflection factor of the target surface

A statement concerning a minimum reflectance is difficult to make because even a small diffuse fraction can be evaluated from highly reflecting surfaces. This is done by determining the intensity of the diffuse reflection from the CMOS signal in real time and subsequent compensation, see 3.2. Dark or shiny objects being measured, e.g. black rubber, may require longer exposure times. The exposure time is dependent on the measuring rate and can only be increased by reducing the sensor's measuring rate.

5.1.2 Error Influences

5.1.2.1 Light from other Sources

Thanks to their integrated optical interference filters the optoNCDT 1420 sensors offer outstanding performance in suppressing light from other sources. However, this does not preclude the possibility of interference from other light sources if the objects being measured are shiny and if lower measuring rates are selected. Should this be the case it is recommended to use suitable shields to screen the other light sources. This applies in particular to measurement work performed in close proximity to welding equipment.

5.1.2.2 Color Differences

Because of intensity compensation, color difference of targets affect the measuring result only slightly. However, such color differences are often combined with different penetration depths of the laser light into the material. Different penetration depths then result in apparent changes of the measuring spot size. Therefore color differences in combination with changes of penetration depth may lead to measuring errors.

5.1.2.3 Temperature Influences

When the sensor is commissioned a warm-up time of at least 20 minutes is required to achieve uniform temperature distribution in the sensor. If measurement is performed in the micron accuracy range, the effect of temperature fluctuations on the sensor holder must be considered. Due to the damping effect of the heat capacity of the sensor, sudden temperature changes are only measured with delay.

5.1.2.4 Mechanical Vibration

If the sensor is to be used for resolutions in the μm to sub- μm range, special care must be taken to ensure stable and vibration-free mounting of sensor and target.

5.1.2.5 Movement Blurs

If the objects being measured are fast moving and the measuring rate is low, it is possible that movement blurs may result. Always select a high measuring rate for high-speed operations, therefore, in order to prevent errors.

5.1.2.6 Surface Roughness

Laser-optical sensors detect the surface using an extremely small laser spot. They also track slight surface unevenness. In contrast, a tactile, mechanical measurement, e.g. using a caliper, detects a much larger area of the measurement object. In case of traversing measurements, surface roughnesses of $5\ \mu\text{m}$ and more lead to an apparent distance change.

Suitable parameters for the averaging number may improve the comparability of optical and mechanical measurements.

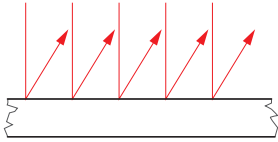

Ceramic reference surface

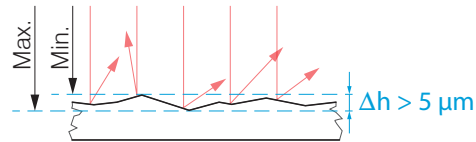

Structured surface

Recommendation for parameter choice:

The averaging number should be selected in such a way that a surface area the size of which is comparable to those with mechanical measurements is averaged.

5.1.2.7 Angle Influences

Tilt angles of the target in diffuse reflection both around the X and the Y axis of less than 5° only have a disturbing effect with surfaces which are highly reflecting.

These influences have to be explicitly considered when scanning profiled surfaces. Basically the angle behavior of triangulation is liable to the reflectivity of the measuring object surface.

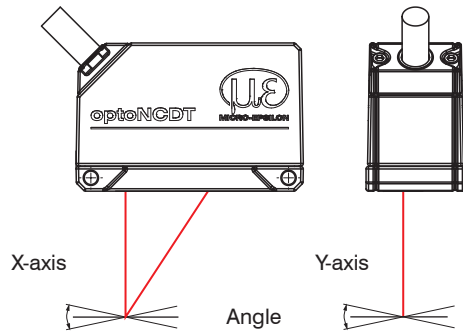
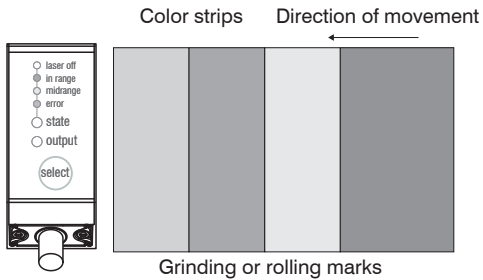

Fig. 9 Measurement errors through tilting with diffuse reflection

5.1.3 Optimizing the Measuring Accuracy



In case of rolled or polished metals that are moved past the sensor the sensor plane must be arranged in the direction of the rolling or grinding marks. The same arrangement must be used for color strips.

Fig. 10 Sensor arrangement in case of ground or striped surfaces

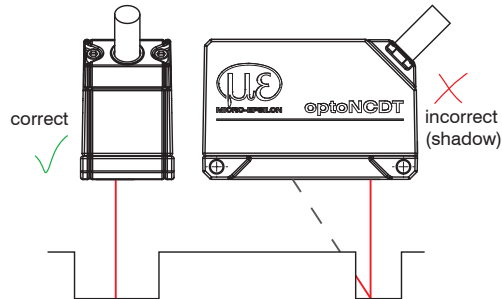

In case of bore holes, blind holes and edges in the surface of moving targets the sensor must be arranged in such a way that the edges do not obscure the laser spot.

Fig. 11 Sensor arrangement for holes and ridges

5.2 Mounting, Dimensions

The optoNCDT 1420 sensor is an optical system for measurements with micrometer accuracy. The laser beam must be directed perpendicularly onto the surface of the target. In case of misalignment it is possible that the measurement results will not always be accurate.

i Make sure it is handled carefully when installing and operating.

➤ Mount the sensor by means of 2 screws type M3 or by means of through bores (mounting holes) for M2 with the screws from the accessories.

Bolt connection

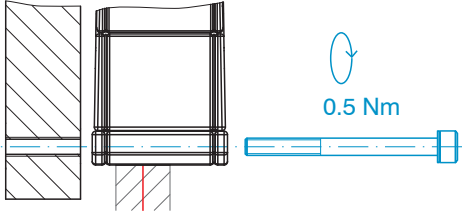

Through length	Screw depth	Screw	Washer	Torque
	Minimum	ISO 4762-A2	ISO 7089-A2	$\mu = 0.12$
mm	mm	2 pieces		Nm
20	5.0	M2 x 25	A2.2	0.5

Direct fastening

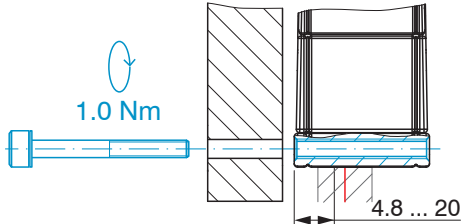

Screw depth		Screw	Torque
Minimum	Maximum	ISO 4762-A2	$\mu = 0.12$
mm	mm	2 pieces	Nm
4.8	20	M3	1.0

Fig. 12 Mounting conditions

The bearing surfaces surrounding the through-holes (mounting holes) are slightly raised.

i Mount the sensor only to the existing holes on a flat surface. Clamps of any kind are not permitted. Do not exceed torques.

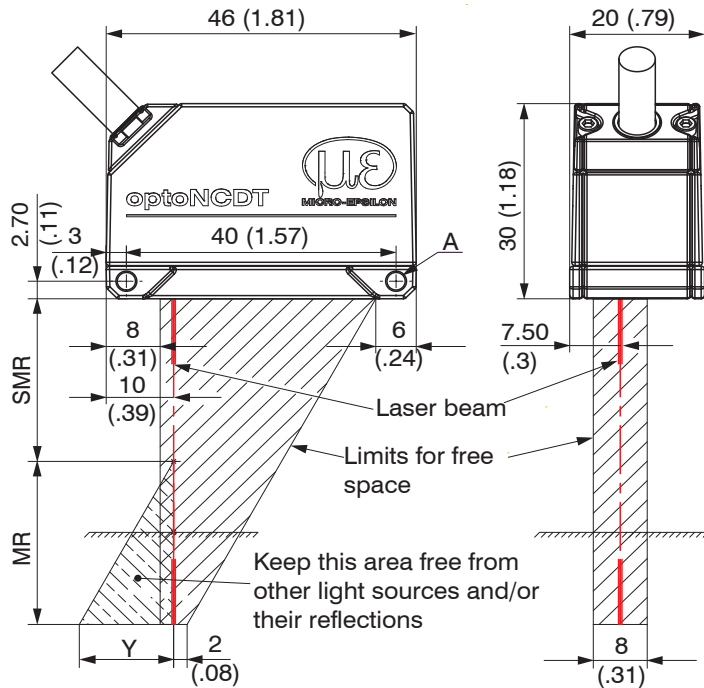

ILD 1420-		10	25	50	100	200	500
MR	mm	10	25	50	100	200	500
SMR	mm	20	25	35	50	60	100
EMR	mm	30	50	85	150	260	600
Y	mm	10	21	28	46	70	190

The indicated free space in the reception area, see Fig. 13, has to be kept clear from foreign objects and extraneous light of other laser sensors at least until the end of measuring range.

MR = Measuring range
 SMR = Start of measuring range
 MMR = Mid of measuring range
 EMR = End of measuring range
 FSO = Full scale output

Fig. 13 Dimensional drawing and free space for optics

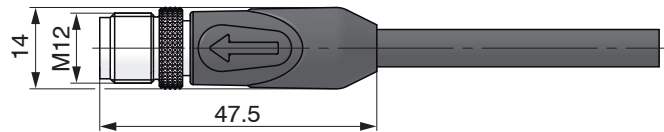
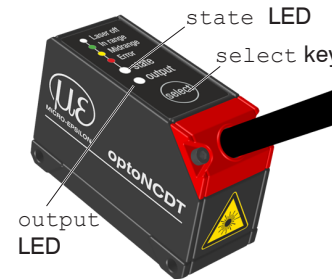

Fig. 14 Dimensional drawing M12 cable connector
 optoNCDT 1420

A: 2x M3 for direct fastening or 2x M2 through-bore (mounting hole) for bolt connection

5.3 Indicator Elements at Sensor

LED State	Meaning
green	Measuring object within sensor range
yellow	Mid range
red	Error - e.g. Poor target or out of range
off	Laser off
LED Output	Meaning
green	RS422 measurement value output
yellow	RS422 and current output are switched off. The RS422 and the current output can be switched on. Web interface can also be switched on.
red	Current 4 ... 20 mA measurement value output
off	Sensor off, no supply



The programmable select key calls up the `Masters` and `Teaching` functions. By factory default the `select` key is only active for 5 minutes after switching on the supply voltage. After that it will be automatically locked. The keylock can be programmed via internal websites or ASCII commands.

5.4 Electrical Connections

5.4.1 Connection Possibilities

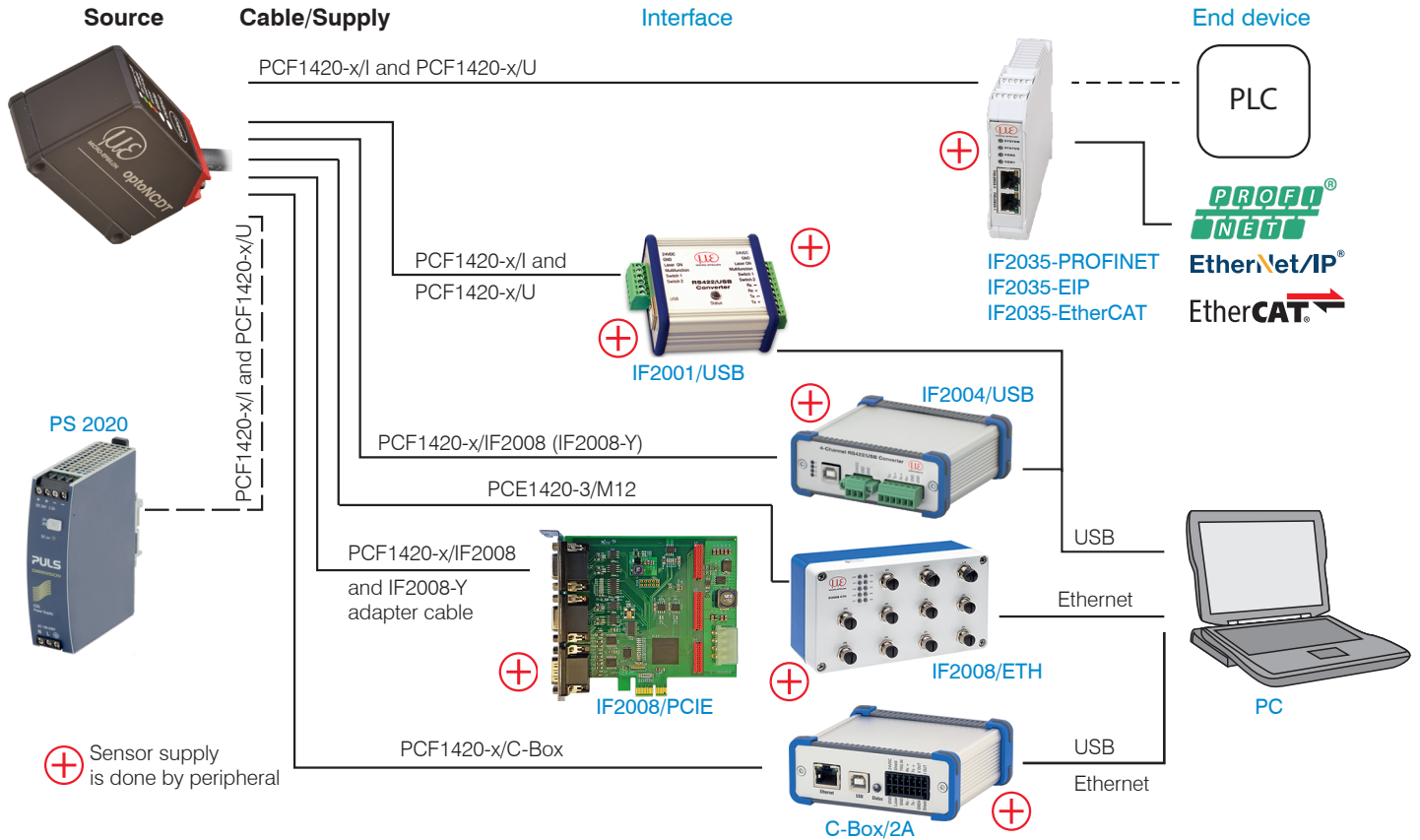

Fig. 15 Connection examples on ILD 1420 optoNCDT 1420

The different periphery devices can be connected by the illustrated connection cables to the 14-pin sensor plug, see Fig. 15. The converters IF2001/USB and IF2004/USB, the calculation unit C-Box/2A, the interface module IF2035 and the PCI interface card IF2008/PCIE also supply the supply voltage (24 VDC) of the sensor. Power to the converters is supplied e. g. by the optional power supply PS 2020.

Periphery device	Sensor channels	Application / terminal device
IF2001/USB, RS422 USB converter	one	PC
IF2035-PROFINET / -EIP / -EtherCAT	one	PLC
C-Box/2A	two	PC
IF2004/USB	four	PC
IF2008/PCIE, PCI interface card	four	PC
IF2008/ETH	eight	PC
PLC, ILD 1420 or the like	---	Functional input: trigger
Switch, key, PLC or the like	---	Switching input laser On/Off

Fig. 16 Max. sensor channels on the peripheral devices

5.4.2 Pin Assignment

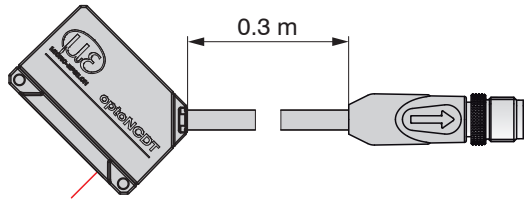

ILD1420 with pigtail (M12-cable connector)

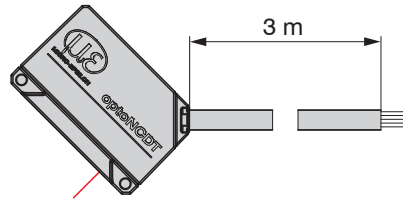

ILD1420 with open ends

The shielding of the cable is connected to the sensor housing. The sensor cable is not cable carriers suitable. One end is molded on the sensor, the other end has free leads with ferrules or a pigtail with a M12 male connector.

Signal	Pin	Color sensor cable 1	Description	Specification, Wiring	<p>Solder pin side female cable connector</p>
RS422 Rx+	3	Green	Serial input	Internally terminated with 120 Ohm	
RS422 Rx-	4	Yellow	Serial output	Terminate externally with 120 Ohm	
RS422 Tx+	5	Gray			
RS422 Tx-	6	Pink			
V_+	7	Red	Supply voltage	11 ... 30 VDC, typ. 24 VDC, $P < 2\text{ W}$	
Laser on/off	8	Black	Switch input	Laser is active, if input is connected with GND	
Multifunction input	9	Violet		Multifunction input (TrigIn, Zero/Master, TeachIn)	
Error	10	Brown	Switch output	$I_{\max} = 100\text{ mA}$, $V_{\max} = 30\text{ VDC}$, Programmable switching characteristic: (NPN, PNP, Push-Pull)	
I_{OUT}	11	White	4 ... 20 mA	$R_{\text{Load}} = 250\text{ Ohm}$: $V_{\text{out}} 1 \dots 5\text{ V}$ with $V_+ > 11\text{ V}$ $R_{\text{Load}} = 500\text{ Ohm}$: $V_{\text{out}} 2 \dots 10\text{ V}$ with $V_+ > 17\text{ V}$	
GND	12	Blue	Ground potential	Supply and signal ground	
Connector housing		Shield	Sensor housing	Connect with potential equalization	

The PCF1420 supply and output cable is drag-chain suitable, see A 1 (optional accessory). One end of the cable has a molded M12 cable connector, the other end has braids with ferrules.

1) Integrated sensor cable, PCF1420-x/I and PCF1420-x/U

5.4.3 Supply Voltage

Nominal value: 24 VDC (11 ... 30 V, P < 2 W).

- Switch on the power supply unit once wiring is completed.
- Connect the inputs “7” and “12” at the sensor with a 24 V supply voltage.

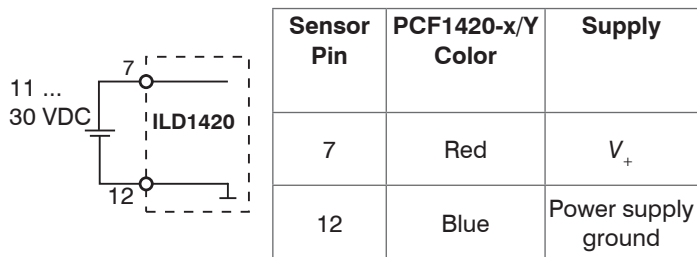

Use the supply voltage for measurement instruments only and not for drive units or similar sources of pulse interference at the same time. MICRO-EPSILON recommends using an optional available power supply unit PS2020 for the sensor.

Fig. 17 Connection of supply voltage

5.4.4 Laser on

The measuring laser on the sensor is activated via an HTL switch input. This is advantageous if the sensor has to be switched off for maintenance or similar. Switching can be done with a transistor (for example open collector in an optocoupler) or a relay contact.

i If pin 8 is not connected with Pin 12, the laser is off.

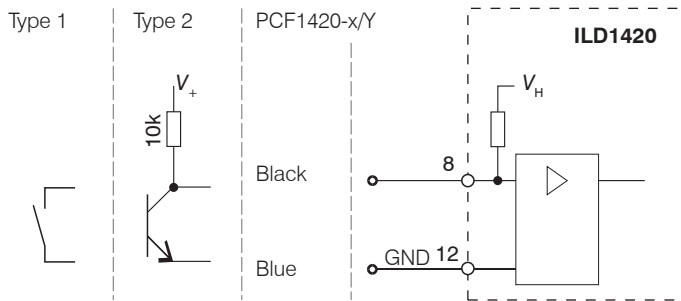

There is no external resistor for current limiting required. Connect Pin 8 with Pin 12 for permanent „Laser on“.

Reaction Time for Laser-On: Correct measuring data are sent by the sensor approximately 1 ms after the laser was switched on.

Fig. 18 Electrical wiring for laser on

5.4.5 Analog Output

The sensor provides a current output 4 ... 20 mA.

i The output may not be continuously operated in short circuit operation without load resistor. The short circuit operation leads to durable thermal overload and thus for automatic overload shutdown of the output.

▶ Connect the output 11 (white) and 12 (blue) on the sensor to a measuring device.

Sensor	
12-pin M12 cable connector	Sensor cable
I_{OUT} (Pin 11)	White
GND (Pin 12)	Blue

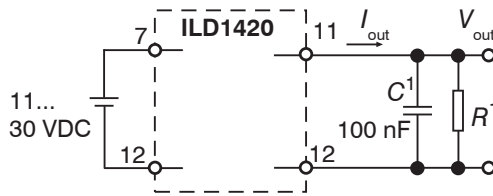

When using a PCF1420-x/U you will get an analog voltage at the output in the range of 1 ... 5 V.

$R = 250 \text{ Ohm}$:

$V_{OUT} 1 \dots 5 \text{ V at } V_+ > 11 \text{ V}$

$R = 500 \text{ Ohm}$:

$V_{OUT} 2 \dots 10 \text{ V at } V_+ > 17 \text{ V}$

Fig. 19 Wiring for voltage output

1) The components are already included in PCF 1420-x/U.

5.4.6 Multifunctional Input

The multifunctional input enables the functions Triggering, Zeroing/Mastering, Teaching. The function is dependent on the programming of the input and of the time behavior of the input signal.

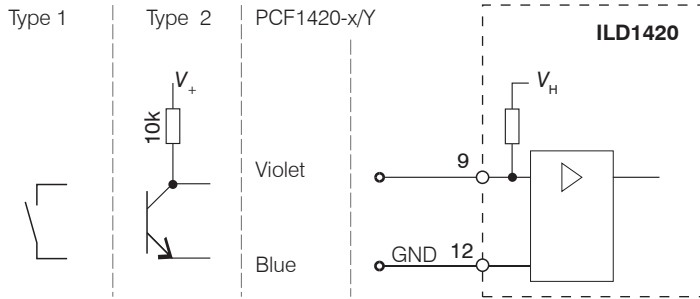

The input is not galvanically isolated.

Internal pull up resistance, an open input is noticed as High.

Connect the input with GND to trigger the function.

Fig. 20 Electrical wiring for multifunctional input

5.4.7 RS422 Connection with USB Converter IF2001/USB

Disconnect or connect the D-sub connection between RS422 and USB converter when the sensor is disconnected from power supply only.

Sensor		End device (converter)
12-pin M12 cable connector	Sensor cable	Type IF2001/USB from MICRO-EPSILON
GND (Pin 12)	blue	GND
Tx - (Pin 6)	pink	Rx -
Tx + (Pin 5)	grey	Rx +
Rx - (Pin 4)	yellow	Tx -
Rx + (Pin 3)	green	Tx +



Symmetric differential signals acc. to EIA-422, not galvanically isolated from supply voltage.

Use a shielded cable with twisted cores e.g. PCF1420-x.

Fig. 21 Pin assignment IF2001/USB

Cross the lines for connections between sensor and PC. optoNCDT 1420

5.4.8 Digital Output

The switching characteristic (NPN, PNP, Push-Pull, Push-Pull negated) of the digital output (Error) depends on the programming. The NPN output is e.g. suitable for adjustment to TTL logics with an auxiliary voltage $V_H = +5$ V. The digital output is protected against reverse polarity, overloading (< 100 mA) and over temperature.

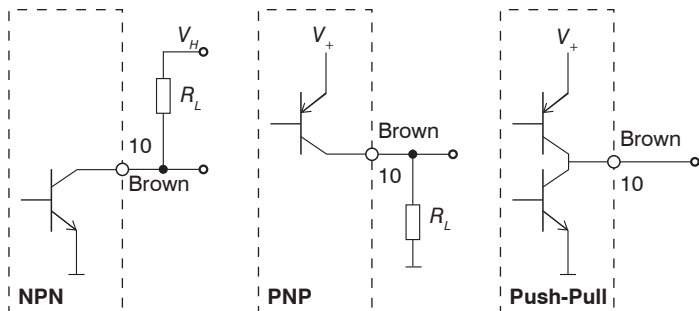

Output is not galvanically isolated.

24V logics (HTL),

$$I_{max} = 100 \text{ mA},$$

$$V_{Hmax} = 30 \text{ V saturation voltage at } I_{max} = 100 \text{ mA:}$$

Low < 2.5 V (output - GND),

High < 2.5 V (output - V_+)

Fig. 22 Electrical wiring digital output

Switching characteristic		
Description	Output active (error)	Output passive (no error)
NPN (Low side)	GND	appr. V_H
PNP (High side)	V_+	appr. GND
Push-Pull	V_+	GND
Push-Pull, negated	GND	V_+

Fig. 23 Switching characteristic digital output

Digital output is activated when measuring object is missing, measuring object too close/too far or when no valid measurement value can be determined.

5.4.9 Connector and Sensor Cable

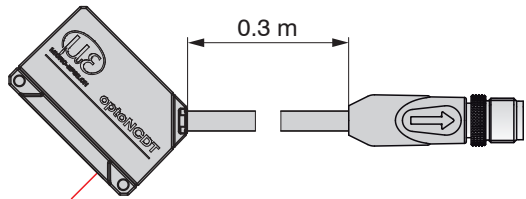

ILD1420 with pigtail (M12-cable connector)

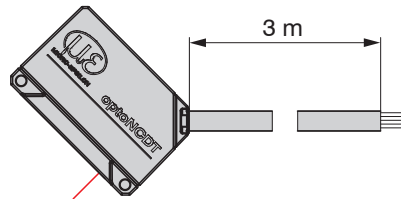

ILD 1420 with open ends

▶ Never fall below the bending radius for the sensor cable of 30 mm (fixed) or 60 mm (dynamic).

i The fixed connected sensor cables are not cable carriers suitable.

i Unused open cable ends must be insulated to protect against short circuits or malfunction of the sensor.

MICRO-EPSILON recommends the use of the drag-chain suitable PCF1420, [see A 1](#) (optional accessories).

▶ Attach the M12 cable connector when using a drag-chain suitable PCF1420 supply and output cable.

▶ Avoid excessive pulling to the cables. Provide strain relieves near the connectors when cables > 5 m are vertically free hanging.

▶ Connect the cable shield to the potential equalization (PE, protective earth conductor) on the evaluator (control cabinet, PC housing) and avoid ground loops.

▶ Never lay signal leads next to or together with power cables or pulse-loaded cables (e.g. for drive units and solenoid valves) in a bundle or in cable ducts. Always use separate ducts.

6. Operation

6.1 Getting Ready for Operation

- ▶ Install and assemble the optoNCDT 1420 in accordance with the instructions set out, [see 5](#).
- ▶ Connect the sensor with the indicator or monitoring unit and the power supply.

The laser diode in the sensor can only be activated if at the input Laser on/off Pin 8 is connected with Pin 12, [see 5.4.4](#).

Once the supply voltage has been switched on the sensor runs through an initialization sequence. This is indicated by the momentary activation of all the LEDs. Once initialization has been completed, the sensor transmits a „->“ via the RS422 interface. The initialization takes up to 10 seconds. Within this period, the sensor executes the `Reset` or the `Bootloader` command through the key `select` only.

To be able to produce reproducible measurements the sensor typically requires a start-up time of 20 minutes.

If the LED `output` is off, this means that there is no supply voltage.

If the LED `state` is off, this means that the laser light source has been switched off.

6.2 Operation via Web Interface

6.2.1 Preconditions

The web interface contains the current settings of the sensor and the periphery. The operation is only possible as long as an RS422 connection to the sensor exists.

The sensor is connected to a PC/notebook via a RS422 converter, supply voltage persist.

▶ Start the program `sensorTOOL`.

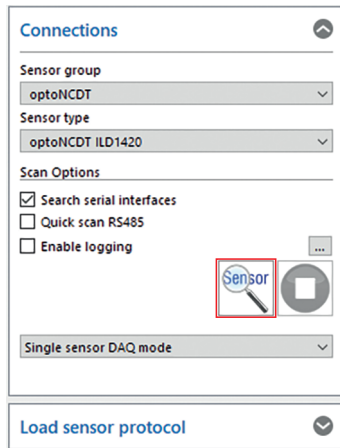

▶ Click the button `Sensor`.

The program searches for connected ILD1420 sensors on available interfaces.

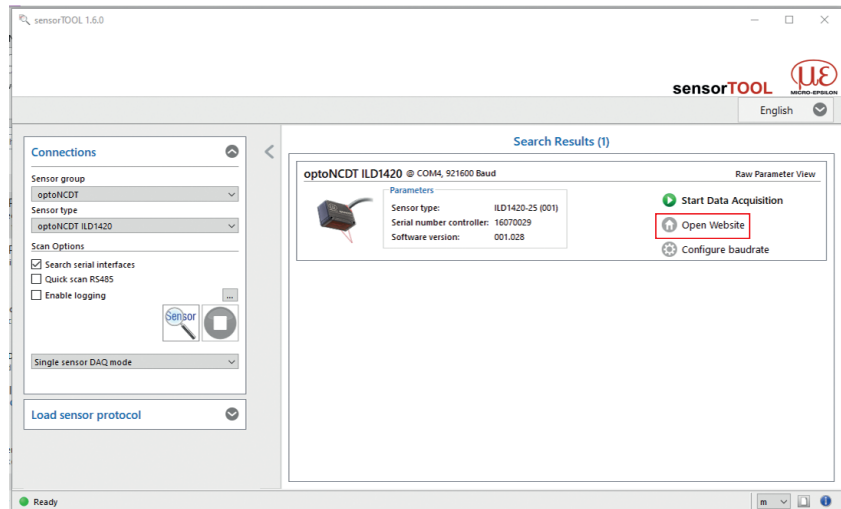

You need a web browser compatible with HTML5 on a PC/notebook.

▶ Choose the desired sensor. Click on the button `Open Website`.

Fig. 24 Auxiliary program for sensor search and to start web interface

6.2.2 Access via Web Interface

▶ Start the web interface of the sensor, see 6.2.1.

Interactive web pages you can use to configure the sensor are now displayed in the web browser. The sensor is active and supplies measurement values.

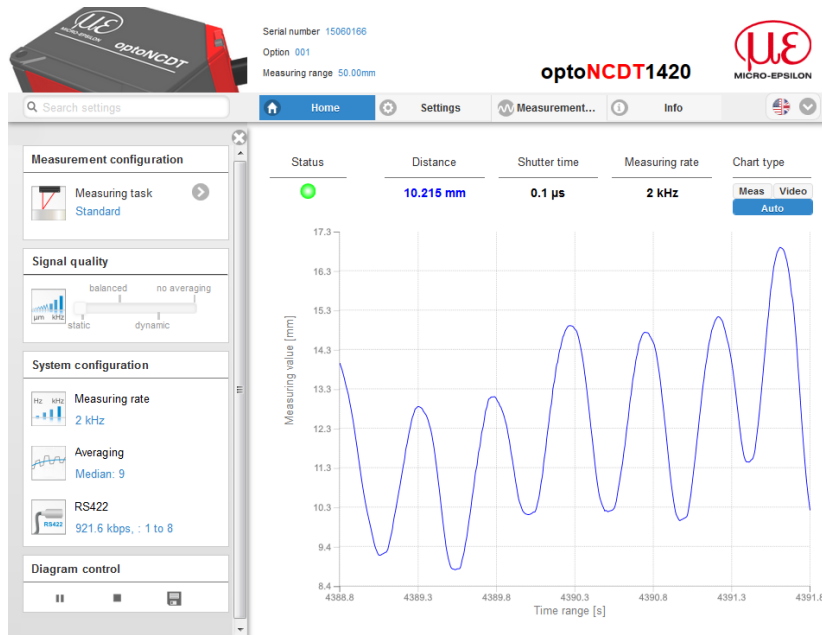

- The search function permits time-saving access to functions and parameters.
- Home: The web interface automatically starts in this view with measurement chart, Measurement configuration and Signal quality.
- Settings: This menu includes all sensor parameters, see Fig. 7.
- Measurement chart: Measurement chart with digital display or video signal display.
- Info: Includes information about the sensor, such as measuring range, serial number and software status.
- Web interface language selection

Fig. 25 First page after web interface has been accessed

The appearance of the websites can change dependent of the functions. Dynamic help text with excerpts from the operating instructions supports you during the sensor configuration.

i Depending on the selected measuring rate and the PC used, measured values may be reduced dynamically in the display. That is, not all measured values are transmitted to the web interface for display and saving.

System configuration



Measuring rate

2 kHz



Averaging

Median: 9



RS422

921.6 kbps, : 1 of 8

The area *System configuration* displays the current settings for measuring rate, averaging and RS422 in blue lettering. Changes to the settings are possible by means of the slide *Signal quality* or by means of the tab *Settings*.

Chart type

Meas

Video

Auto

The area *Diagram type* enables the change between graphical display of the measurement value or the video signal.

6.2.3 Calibration Protocol



Download / Informationen



Betriebsanleitung



Kalibrierprotokoll

You can download the calibration protocol under *Download / Information* in the *Info* menu item.

6.3 Presets, Setups, Measurement Configuration, Signal Quality

Definition

- Preset: Manufacturer-specific program with settings for frequent measuring tasks; cannot be overwritten
- Setup: User-specific program with relevant settings for a measuring task
- Initial setup at boot (sensor start): a favorite can be selected from the setups, which is automatically activated at sensor start. If no favorite is determined from the setups, the sensor activates the Standard preset at startup.

With delivery of the sensor from the factory

- the presets Standard, Multi-Surface and Light penetration are possible
- no setup is available.

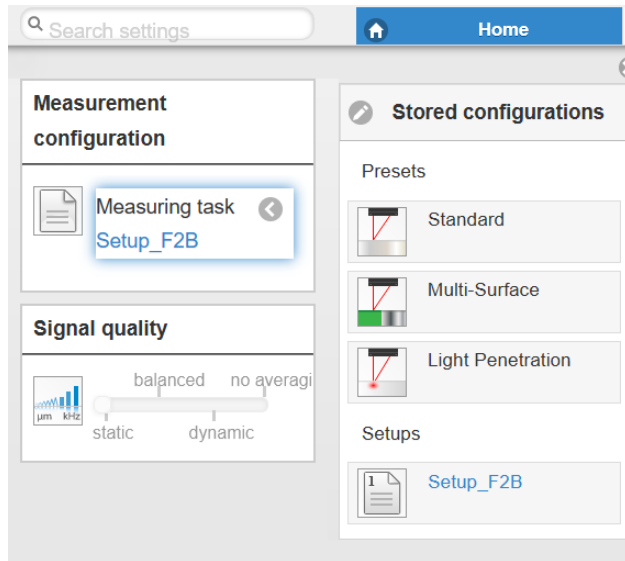

You can select a preset in the tab

Home > Measurement configuration

You can select a setup in the tab

Home > Measurement configuration or

Settings in menu System settings > Load & save

A setup can be stored permanently in the controller, [see 7.4.6.](#)

For all presets, the averaging can be individually adapted to the measuring task via the Signal quality slider.

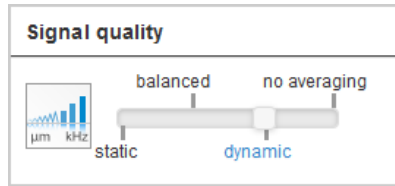

Averaging

- static moving, 128 values
- balanced moving, 64 values
- dynamic Median, 9 values
- no averaging

Description

In the area *Signal quality* you can switch between four given basic settings (static, balanced, dynamic and no averaging). You can instantly see the reaction in the diagram and system configuration.

Presets allow a quick start into the individual measuring task. Selecting a preset which is suitable for the target surface activates a predefined configuration of settings that will produce the best results for the material selected.

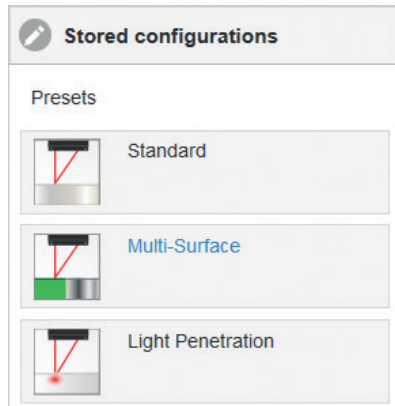

Standard

Ceramics, metal

Multi-Surface ¹

Printed circuit boards (PCB), hybrid material

Light penetration ¹

Plastics (Teflon, POM), Materials with large penetration depth of the laser

i After programming all the settings are to be stored permanently in a set of parameters. The next time you turn on the sensor they are available again. Therefore use the button *Save settings*.

1) Available for the sensor models ILD1420-10/25/50.

6.3.1 Measurement Presentation via Web Browser

▶ Start the measurement value display (Measurement chart) in the horizontal navigation bar.



Fig. 26 Website measurement (distance measurement)

- 1 Stop stops the diagram; data selection and zoom function are still possible. Pause interrupts recording. Save opens the Windows selection dialog for the file name and storage location to save the last 10.000 values in a CSV file (separation using semicolon), which were measured the last 10 seconds independently from the measuring rate.
- 2 This function starts or stops a relative measurement. The master value can also be defined in a submenu here.

- 3 For scaling the measurement value axis (y-axis) of the graphics you can either choose `Auto` (= auto scaling) or `Manual` (= manual setting).
 - 4 The search function enables time-saving access to functions and parameters.
 - 5 In the text boxes above the graphics current values for distance, exposure time, current measuring and display rate and time-stamp are displayed.
 - 6 Choice of a diagram type. In the setting `Auto` the diagram type matching the setting is chosen automatically.
 - 7 Mouse over function. When moving the mouse over the graphic in stopped state curve points are marked with a circle symbol and the related values are displayed in text boxes above the graphic. Peak intensity is also updated.
 - 8 The peak intensity is displayed as bar chart.
 - 9 Scaling of the x-axis can be defined by means of a input field below the time axis.
 - 10 Scaling of the x-axis: you can enlarge (zoom) the overall signal by means of the left slider during ongoing measurement. If the diagram is stopped, you can also use the right slider. The zoom window can also be moved by means of the mouse in the middle of the zoom window (arrow cross).
- i** If you leave the diagram display in a separate tab or window of the browser running, you do not have to restart the description each time.
-  Click the button `Start`, for starting the display of the measurement results.

6.3.2 Video Signal via Web Browser

▶ Start the video signal display with the function `Video` in the area `Diagram` type.

The diagram in the big graphic window on the right displays the video signal of the recipient filed. The video signal in the graphic window displays the intensity distribution above the pixels of the recipient field.

0 % (distance small) on the left and 100 % (distance big) on the right. The related measurement value is marked by means of a vertical line (peak marking).



Fig. 27 Display of video signals

- 1 Stop stops the diagram; data selection and zoom function are still possible. Pause interrupts recording. Save opens the Windows selection dialog for the file name and storage location to save the video signal in a CSV file.

- 2 This function starts or stops a relative measurement.
The master value can also be defined in a submenu here.
- 3 The video curves to be displayed while or after measurement can be switched on or off in addition in the left window. Non active curves are highlighted in gray and can be added by clicking the hook. If you only want to see a single signal, then click on its name.
 - Raw signal (uncorrected CMOS signal, red)
 - Peak marking (vertical blue line), corresponds to the calculated measurement value
 - Linearized measuring range (limited by means of gray shading), cannot be changed
 - Masked range (limited by means of light blue shading), changeable
- 4 For scaling the measurement value axis (y-axis) of the graphics you can either choose `Auto` (= auto scaling) or `Manual` (= manual setting).
- 5 The search function enables time-saving access to functions and parameters.
 - ASCII commands to the sensor can also be sent via the search function.
- 6 In the text boxes above the graphics current values for distance, exposure time, current measuring and display rate and time-stamp are displayed.
- 7 Choice of a diagram type. In the setting `Auto` the diagram type matching the setting is chosen automatically.
- 8 Mouse over function. When moving the mouse over the graphic in stopped state curve points are marked with a circle symbol and the related intensity is displayed. The related x position in % appears above the graphic filed.
- 9 The linearized range is between the gray shading in the diagram and cannot be changed. Only peaks which centers are within this range can be calculated as measurement value. The masked range can be limited on request and is additionally limited by means of a light blue shading on the right and on the left. The remaining peaks in the resulting range are used for evaluation.
- 10 Scaling of the x-axis can be defined by means of a input field below the time axis.
- 11 Scaling of the x-axis: you can enlarge (zoom) the overall signal by means of the left slider during ongoing measurement. If the diagram is stopped, you can also use the right slider. The zoom window can also be moved by means of the mouse in the middle of the zoom window (arrow cross).

By displaying the video signal, you can detect effect of the adjustable measurement task (target material), choice of peak and possible interfering signals by means of reflections.

There is no linear relationship between the position of the peaks in the video signal and the output measurement value.

6.4 Programming via ASCII Commands

As an added feature you can program the sensor via an ASCII interface, physically the RS422. This requires, that the sensor must be connected either to a serial RS422 interface via a suitable interface converter, [see A 1](#), or a plug-in-card to a PC / PLC.

Pay attention in the programs used to the correct RS422 default setting.

Once connected, you can transmit the commands from the appendix, [see A 3](#), via the terminal to the sensor.

6.5 Timing, Measurement Value Flux

The sensor requires three cycles for measurement and calculation without triggering:

Each cycle takes $250 \mu\text{s}$ at a measuring rate of 4 kHz. The measured value N is available at the output after three cycles. The delay between acquisition and output is therefore $750 \mu\text{s}$. As the processing in the cycles occurs parallel, after another $250 \mu\text{s}$, the next measured value (N+1) is output.

7. Set Sensor Parameter

7.1 Preliminary Remarks to the Adjustments

There are different ways to parameterize the optoNCDT 1420:

- using a web browser via the `sensorTOOL` program and the sensor web interface
- ASCII command set and a terminal program via RS422.



If you do not save the programming permanently in the sensor, you lost the settings after turning off the sensor.

7.2 Overview Parameter

The following parameters can be set or changed in the optoNCDT 1420, see tab `Settings`.

Inputs	Laser on/off, Multifunctional input, Key function
Signal processing	Measurement task, Measuring rate, Reset counter, Triggering (Data recording, Data output), Evaluation range (ROI), Peak selection, Error handling, Averaging, Zeroing/Mastering, Data reduction
Outputs	RS422, Analog output, Digital output
System settings	Unit on website, Keylock, Load & Store, Import & Export, Access authorization, Reset controller (factory settings)

7.3 Inputs

➡ Go to the menu `Inputs` in the menu `Settings`.

Laser on/off	<i>On / Off</i>		<i>Laser on/off is only effective when pin 8 is connected to GND.</i>
Multifunctional input	<i>Zeroing (Mastering)</i>	<i>High / Low</i>	<i>Sets the function of the digital input. The Trigger influences capture and export of a measurement value. Zeroing/Mastering sets the current measurement value to the entered master value. Teaching scales the analog output. HTL is defined as active input level.</i>
	<i>Trigger In</i>	<i>High / Low</i>	
	<i>Teaching</i>		
	<i>Inactive</i>		
Key function	<i>Zeroing (Mastering)</i>		<i>Sets the function of the sensor key. Inactive means keylock.</i>
	<i>Teaching</i>		
	<i>Inactive</i>		

7.4 Signal Processing

7.4.1 Preliminary Remark

➡ Go to the menu `Signal processing` in the tab `Settings`.

A diagram appears according to the prior settings in the area `Diagram type` in the right part of the display. The diagram is active and various settings can be seen immediately. You can find references to the chosen setting below.

The menus for the area `Signal processing` are located in the left part.

 Grey shaded fields require a selection.

 Value Dark-bordered fields require you to specify a value.

7.4.2 Measurement Task

The measurement task contains choice of the measuring object (target). The choice of a target loads a predefined sensor configuration which achieves the best results for the chosen material.

Measurement task	<i>Standard</i>	<i>Suitable for materials made of ceramics, metal or filled plastics</i>
	<i>Changing surfaces</i> ¹	<i>Suitable e.g. for Printed circuit boards (PCB) or hybrid materials</i>
	<i>Material with penetration</i> ¹	<i>Suitable for plastics (POM, Teflon), materials with large penetration depth of the laser</i>

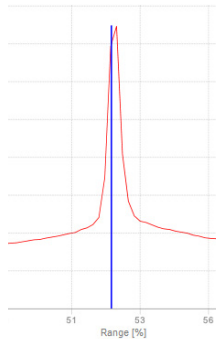

Setting: Standard

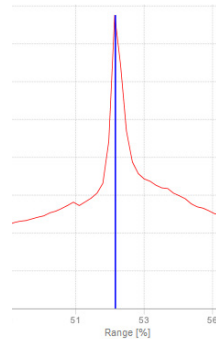

Material with penetration

The choice of measuring object preferences can be observed in the diagram Video signal on the right by means of the position of the blue peak marking in relation to the video signal (raw signal). It should preferably hit in the area of the highest point (peak) of the video signal.

Fig. 28 Example: Video signals (extract) with measuring object material POM

In the setting *Standard* the peak marking (measurement value) of the plastics example POM does not hit the center of gravity of the real peak as its base is distorted asymmetrically by means of penetration of the laser light. This is possible only if the measurement task was set to *Material with penetration*.

In the setting *Changing surfaces* a compromise between penetration and standard finish is chosen which achieves optimum results for both materials. This can also be seen in the diagram distance values (*Meas*) by means of the different distance values for the respective measurement tasks.

1) Available for the sensor models ILD1420-10/25/50.

7.4.3 Measuring Rate

The measuring rate indicates the amount of measurements per second.

 Choose the desired measuring rate.

Measuring rate	250 Hz / 500 Hz / 1 kHz / 2 kHz / 4 kHz / 8 kHz	<i>Use a high measuring rate with light and matt measuring objects. Use a low measuring rate with dark and shiny measuring objects (e.g. black lacquered surfaces) to improve the measuring result.</i>
----------------	--	---

With a maximum measuring rate of 8 kHz the CMOS element is exposed 8,000 times per second. The lower the measuring rate, the higher maximum exposure time.

Measuring rate is set to 2 kHz ex works.

 Grey shaded fields require a selection.

 Value Dark-bordered fields require you to specify a value.

7.4.4 Triggering

7.4.4.1 General

The optoNCDT 1420 measurement input and output is controllable through an external trigger signal or a command. Triggering affects the analog and digital output. The measurement value at the time of triggering is output delayed, [see 6.5](#).

- Triggering does not influence the timing so that between the trigger event (level change) and the start of output always lie 3 cycles + 1 cycle (Jitter).
- Micro-Epsilon recommends the abdication of data reduction, for example, by sub-sampling when the triggering is used.
- The multifunctional input is used as external trigger input, [see 5.4.6](#).
- Factory setting: no triggering, the sensor starts data transmission right after start-up.
- Pulse duration of the "Trigger in" signal must be at least 50 μ s.

Triggering of measured value acquisition and output have the same time behavior.

Input trigger / Output trigger	Level			A continuous measurement task is following as long as the chosen level remains the same. Choice of level, see 7.3 . Pulse duration must be at least a cycle time. The following pause must be at least a cycle time.
	Edge	infinite		Edge selection, see 7.3 . "0" end trigger, "1 ... 16382" values per trigger, "16383" endless trigger
		manual	Number	
	Software	infinite		A software triggering is started by clicking the button Release trigger. "0" end trigger "1 ... 16382" values per trigger, "16383" endless trigger
manual		Number	Value	
Inactive				No triggering

Valid with triggering:

$$f_T < f_M \quad f_T \quad \text{Trigger frequency}$$

$$f_M \quad \text{Measuring rate}$$

Implemented trigger conditions:

Grey shaded fields require a selection.

Value Dark-bordered fields require you to specify a value.

Level triggering with high level / low level.

Continuous measurement input or output, as long as the selected level is applied. Then stops the data output.

The pulse duration must be at least one cycle time. The subsequent break must also be at least one cycle time.

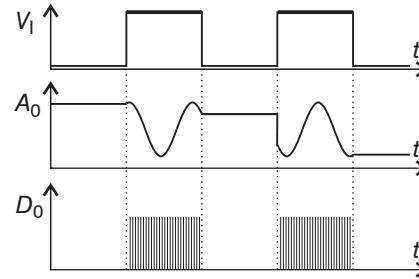

Fig. 29 High trigger level (above) with analog output A_0 and digital output signal D_0 (below)

Edge triggering with rising or falling edge.

Starts measured value acquisition or output as soon as the chosen edge is applied to the trigger input. The sensor outputs a fixed number of measurement values when trigger conditions have been met. Value range from 1 ... 16383. After termination of data output the analog output sticks to the last value (sample & hold).

Pulse duration must be at least 50 μs .

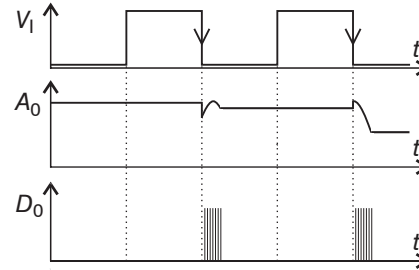

Fig. 30 Trigger edge HL (above) with analog output A_0 and digital output signal D_0 (below)

Software triggering. Starts the measurement value output, when a software command comes. The trigger time is defined more inaccurately. After the trigger event the sensor outputs the preset number of measurement values or starts a continuous measurement value output. If "0" is selected for the number of measurement values, the sensor stops the triggering and the continuous value output.

Measurement output can also be stopped by means of a command.

7.4.4.2 Signal Processing - Trigger for Acquiring Values

The current field signal is processed only after a valid trigger event, and it is used to calculate the measurement values. The measurement values are then forwarded for further calculation (e.g. averaging) and for output via an analog or a digital interface.

When calculating averages, measurement values recorded immediately before the trigger event cannot be included; instead older measurement values are used, which were recorded during previous trigger events.

Activating data recording trigger deactivates data output trigger.

7.4.4.3 Signal Processing - Value Output Trigger

Measurement values are calculated continuously and independently of the trigger event. A trigger event simply triggers the value output via a digital interface. Therefore, any values measured immediately before the trigger event are included in calculating mean values (averages).

Activating data output trigger deactivates data recording trigger.

7.4.5 Mask Evaluation Area, ROI

Masking limits evaluation area (ROI - Region of interest) for distance calculation in the video signal. This function is used to suppress e.g. disturbing reflections or extraneous light.

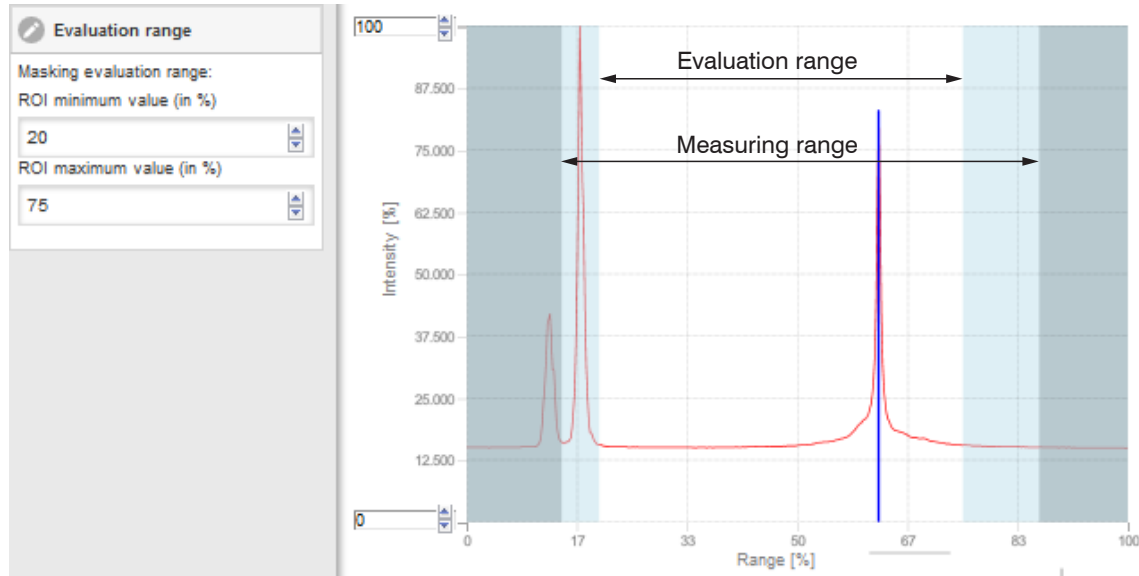
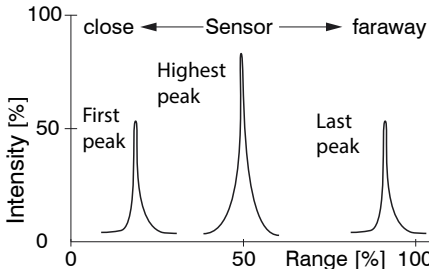

Fig. 31 Light blue areas limit the evaluation area

The exposure control optimizes the peaks in the evaluation range. Thus, small peaks can be optimally controlled when a high interfering peak is outside the evaluation range.

7.4.6 Peak Selection

Peak selection	<i>First peak / highest peak / last peak</i>	<p>Defines, which signal is used for the evaluation in the line signal.</p> <p>First peak: nearest peak to the sensor.</p> <p>Highest peak: standard, peak with the highest intensity.</p> <p>Last Peak: widest peak to the sensor.</p>	
----------------	--	---	--

A correct measuring result can be determined only for the first peak when a measuring object which consists of several transparent layers.

7.4.7 Error Handling

Error handling adjusts the behavior of the analog output and the RS422 interface in the event of an error.

Error handling	Error output, no value	<i>Analog output supplies 3 mA instead of the measurement value. The RS422 interface outputs an error value.</i>	
	Retain last value infinitely	<i>Analog output and RS422 interface stick to the latest valid value.</i>	
	Retain last value	1 ... 1024	Value

If no valid measurement value can be detected, an error is output. If this disrupts further processing, you can alternatively hold the last valid value over a specific period of time i.e. it can be output again. After expiry of the chosen number an error value is output.

 Grey shaded fields require a selection.

 Value Dark-bordered fields require you to specify a value.

7.4.8 Averaging

7.4.8.1 General

The averaging is recommended for static measurements or slowly changing values.

Averaging	<i>Inactive</i>			<i>Measurements are not averaged.</i>
	<i>Moving N values</i>	2 / 4 / 8 ... 128	Value	<i>Indication of averaging mode. The averaging number N indicates the number of consecutive measurement values to be averaged in the sensor.</i>
	<i>Recursive N values</i>	2 ... 32767	Value	
	<i>Median N values</i>	3 / 5 / 7 / 9	Value	

The averaging of measurement values is effected after the calculation of the displacement values prior to the output via the interfaces.

The purpose of averaging is to:

- Improve the resolution
- Eliminate signal spikes or
- „Smooth out“ the signal.

Averaging has no effect on linearity.

In completion of the measuring cycle the internal average is calculated again.

i The preset average value and the number of averaging are to save in the sensor, so that they remain after switching off.

Averaging does not affect the measuring rate or data rates in digital measurement value output. The averaging numbers can also be used if programmed via the digital interfaces. The sensor optoNCDT 1420 is supplied ex factory with the default setting „Median 9“, that is, averaging with Median and 9 measurements.

Depending on the average type and the averaging number there is a different settling time, [see 6.5](#).

 Grey shaded fields require a selection.

 Value Dark-bordered fields require you to specify a value.

7.4.8.2 Moving Average

The selected number N of successive measurement values (window width) is used to generate the arithmetic average value M_{gl} on the basis of the following formula:

$$M_{gl} = \frac{\sum_{k=1}^N MV(k)}{N}$$

MV = Measurement value,

N = Averaging number,

k = Running index

M_{gl} = Averaging value or output value

Mode:

Each new measurement value is added and the first (oldest) measurement value from the averaging process (from the window) taken out again. This results in short transient recovery times for jumps in measurement values.

Example with $N = 4$

... 0, 1, 2, 2, 1, 3

↓

$$\frac{2, 2, 1, 3}{4} = M_{gl}(n)$$

... 1, 2, 2, 1, 3, 4

↓

$$\frac{2, 1, 3, 4}{4} = M_{gl}(n+1)$$

Measurement values

Output value

Characteristics:

When moving averaging in the optoNCDT 1420 only powers of 2 for the averaging number N are allowed.

Range of values for number of average N is 1 / 2 / 4 / 8 ... 128.

7.4.8.3 Recursive Average

Formula:

$$M_{\text{rek}}(n) = \frac{MV_{(n)} + (N-1) \times M_{\text{rek}}(n-1)}{N}$$

MV = Measurement value,

N = Averaging number,

n = Measurement value index

M_{rek} = Averaging value or output value

Mode:

Each new measurement value $MV(n)$ is added, as a weighted value, to the sum of the previous measurement values $M_{\text{rek}}(n-1)$.

Characteristics:

The recursive average permits a high degree of smoothing of the measurement values. However, it requires extremely long transient recovery times for steps in measurement values. The recursive average shows low pass behavior. Range of values for number of average N is 2 ... 32767.

7.4.8.4 Median

The median is generated from a pre-selected number of measurement values.

Mode:

To do so, the incoming measurement values (3, 5, 7 or 9 measurement values) are resorted again after every measurement. The average value is then given as the median. In generating the median in the sensor, 3, 5, 7 or 9 measurement values are taken into account, that is, there is never a median of 1.

Characteristics:

This averaging mode suppresses individual interference pulses. The measurement value curve is not smoothed to a great extent.

Example: Average from five measurement values

... 0 1 2 4 5 1 3 → Sorted measurement values: 1 2 3 4 5 Median_(n) = 3

... 1 2 4 5 1 3 5 → Sorted measurement values: 1 3 4 5 5 Median_(n+1) = 4

7.4.9 Zeroing and Mastering

By zeroing and mastering you can set the measurement value to a set point in the measuring range. The output range is moved thereby. This function makes sense, for example, for several adjacent measuring sensors or in the case of the thickness and planarity measurement.

Zeroing/ Mastering	Inactive		<i>Normal measurement value or Zeroing/Mastering is undone.</i>
	Active	Value	<i>Indication e. g. of thickness of a master part. Value range max. 0 up to + 2 x measuring range</i>

Setting masters is used to compensate mechanical tolerances in the measurement setup of the sensors or to adjust the temporal (thermal) changes in the measurement system. The masters measurement, also a known as the calibration measurement, is given a set point.

The value which is given during measurement on the sensor output of the “mastering object” is the `master value`. The zero-setting is a characteristic of the mastering, because here the master value is 0.

When mastering the sensor’s characteristic is parallel displaced. The displacement of the characteristic curve reduces the usable measurement range of the sensor the further the master value is away from the master position.

Sequence for Mastering / Zeroing:

- ➡ Bring target and sensor in the desired position together.
- ➡ Send the master command.

The master command waits for 2 seconds on the next measurement value and masters it. If no measurement value is received within this time, for example by external triggering, the command returns with the error `E220 Timeout back`.

After the mastering, the sensor gives new measurement values, related to the master value. The non-mastered condition applies by means of a reset with the button `Inactive`.

i `Zeroing/Mastering` requires that a target is within the measurement range.
i `Zeroing/Mastering` has an influence on the digital and the analog output.

An invalid master value, e. g. no peak available, will be acknowledged with the `E602 Master value is out of range error`.

 Grey shaded fields require a selection.

 `Value` Dark-bordered fields require you to specify a value.

7.4.9.1 Zeroing, Mastering with Select Key

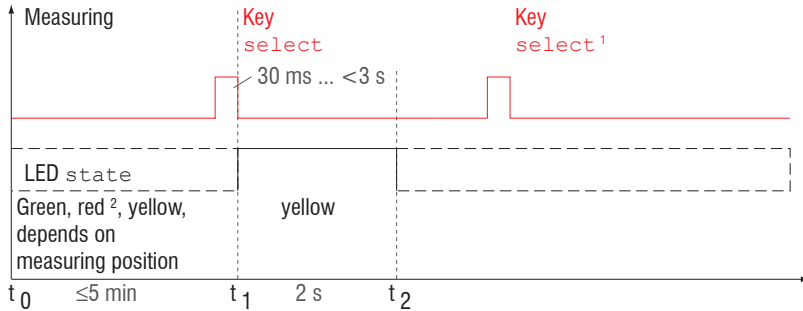

Fig. 32 Flow chart for zeroing, mastering (key select)

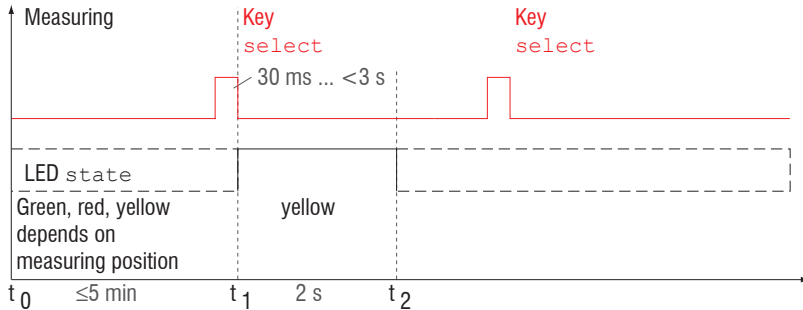

Fig. 33 Flow chart for the return of zero setting and mastering

- 1) The key `Select` remains without effect since key lock is active.
- 2) The master value is not applied when LED State is red, flash frequency 8 Hz for 2 s.

i The key `Select` is locked according to factory settings after expiry of 5 min. You can unlock the keylock e.g. via the web interface, see 7.6.3.

The function Zeroing/Mastering can be used several times in succession. Between repetition of the function Zeroing/Mastering a brake of 1 s is necessary. The function Zeroing/Mastering can also be combined with the multifunctional input.

7.4.9.2 Zeroing, Mastering with Hardware Input

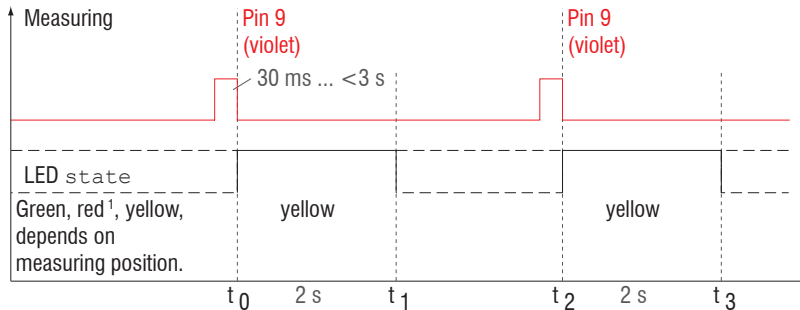

Fig. 34 Flow chart for zeroing, mastering (hardware input)

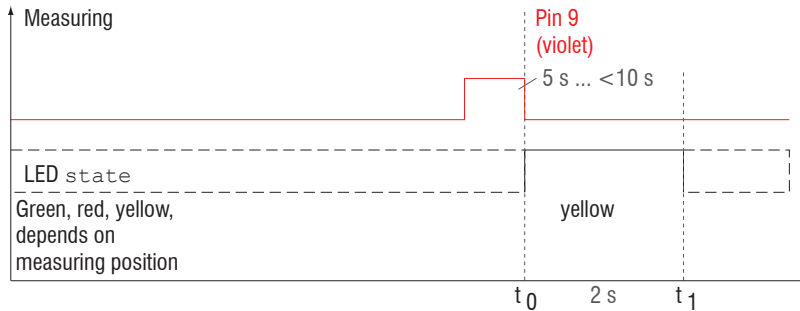

Fig. 35 Flow chart for the return of zero setting and mastering

The function zeroing/mastering can be applied successive in several times. Between repeating the zeroing/mastering function a pause of 1 s is required. The zeroing/mastering function can also be combined with the `select` key.

1) With red `State` LED, the master value is not accepted, flashes with 8 Hz for 2 s.

i A pulse on the functional input can be made via pin 9 pigtail or via the violet wire on the sensor cable or via the PCF1420-x. Details of the hardware input can be found in the electrical connections, see 5.4.6.

7.4.10 Data Reduction, Output Data Rate

Data reduction	<i>Value</i>	<i>Instructs the sensor, which data are excluded from the output, and thus the amount of transmitted data is reduced.</i>
Reduction applies for	<i>RS422 / Analog</i>	<i>The interfaces, which are provided for the sub-sampling, are to be selected with the checkbox.</i>

You can reduce the measurement output in the sensor if you set the output of every nth measurement value in the web interface or by command. Data reductions causes that only n-th measurement value is output.

The other measurement values are rejected. The reduction value n can range from 1 (each measurement value) to 3,000,000. This allows you to adjust slower processes, such as a PLC, to the fast sensor without having to reduce the measuring rate.

 Grey shaded fields require a selection.

 Value Dark-bordered fields require you to specify a value.

7.5 Outputs

7.5.1 Overview

RS422	Baud rate	9.6 / 19.2 / 56.0 / 115.2 / 230.4 ... / 1000 kBps		Transmission rate with binary data format.	
	Output data	Distance / Shutter time / Intensity / Sensor state / Measurement counter / Non-linearized center of gravity / Time stamp / Video raw signal		The data which are provided for the transmission are to activate with the checkbox.	
Analog output	Standard scale			Start of measuring range 4 mA, end of measuring range 20 mA	
	Two-point scale	Minimum value	Value	Always 2 points which mark the start and end of a new measuring range are taught. Reversal of the output signal is possible with two-point scaling.	
		Maximum value	Value		
Switching output	Inactive			Regulates the switching performance of the digital output (Error), see 5.4.8. Analog range: digital output switches when the scaled analog range is exceeded. Measuring range: The digital output is switched when the peak is not (entirely) in evaluation range (ROI). Limit monitoring: digital output switches when the limit is exceeded.	
	Analog range	NPN / PNP / PushPull / PushPullNeg			
	Measuring range	Limit monitoring			NPN / PNP / PushPull / PushPullNeg
		Limit	Value		
		Hysteresis	Value		
		Minimum holding period	Value		
Output Interface	Web interface / Analog / RS422			Decides via the used interface for measurement output. A parallel measurement output via multiple channels is not possible. When choosing web interface measurement values are not output via RS422 or current output.	

7.5.2 Digital Output, RS422

Details can be found in the description of the RS422 digital interface, [see 8](#).

7.5.3 Analog Output Scaling

7.5.3.1 Output Scaling

- Max. output range: 4 mA ... 20 mA
- Output gain ΔI_{OUT} : 16 mA = 100 % MR
- Error value: 3.0 mA ($\pm 10 \mu\text{A}$)

The teaching scales the analog output (4 to 20 mA) for a part of the measuring range. This allows you to optimize the resolution for the analog measurement range. Only the current and switching output will be affected by the 2 point calibration. Therefore you define a new start and end for the measurement range. This teaching procedure can be performed live via the `select` key, the multifunctional `input` or via the webinterface.

i With a user defined output scaling you can use the digital output, [see 5.4.8](#), as a programmable limit switch.

The measurement object positions for `Teach 1` and `Teach 2` have to differ from each other. The teaching process requires a valid measuring signal. The teaching process is terminated at

- no target,
- target not evaluated,
- to close to the sensor - beyond SMR or
- to far from the sensor - beyond EMR.

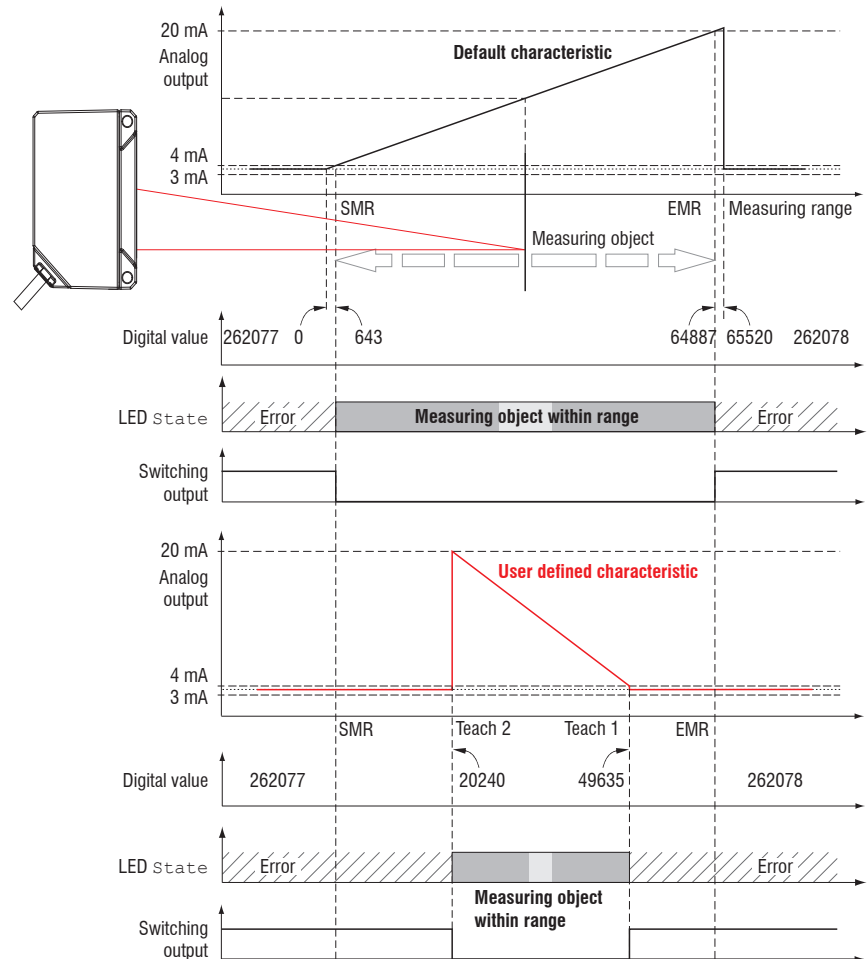

Fig. 36 Default characteristic (black), reverse, user defined characteristic (red)

7.5.3.2 Output Scaling with Key Select

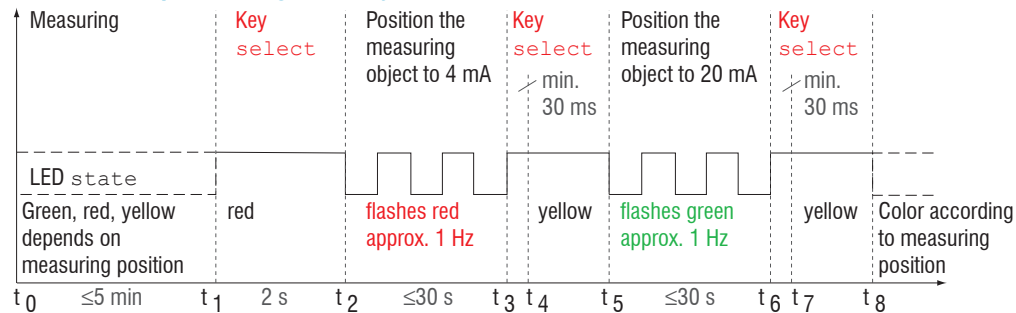

Fig. 37 Flow chart for output scaling

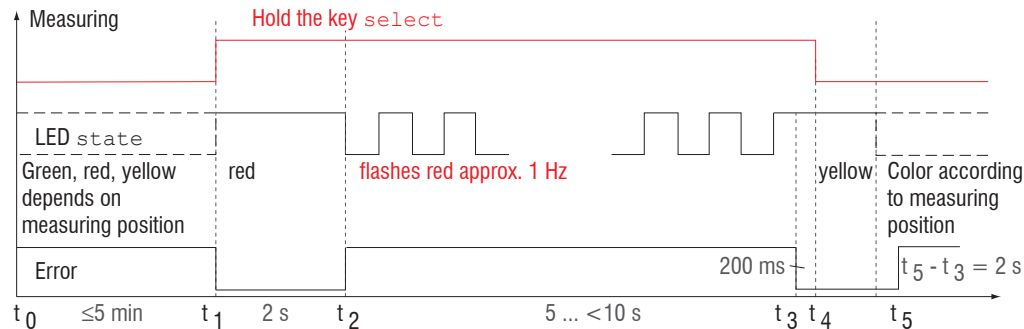

Fig. 38 Flow chart for the return of output scaling

If the key `Select` is pressed longer than 10 s or not within the timeframe while doing the return of the output scaling, an error is shown via `State LED`. In this case the `State LED` is blinking red with 8 Hz for 2 s.

7.5.3.3 Output Scaling via Hardware Input

Scaling of the analog output can be made via an impulse at the functional input, pin 9 pigtail or via the violet wire on the sensor cable or PCF1420-x.

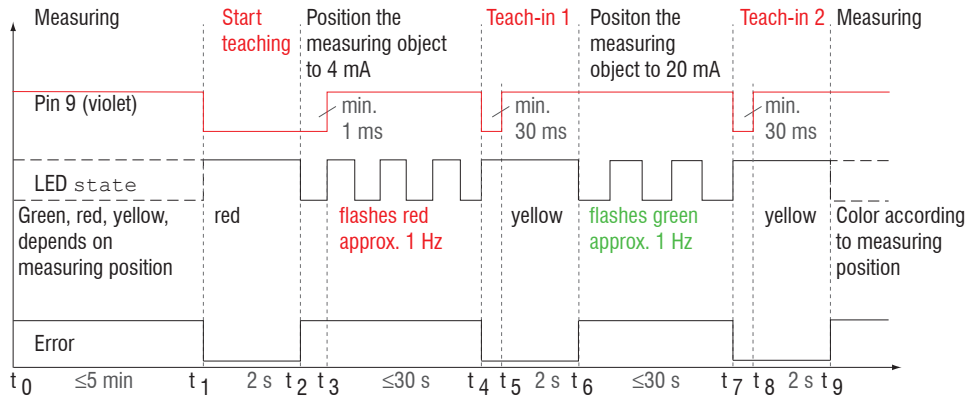

Fig. 39 Flow chart for output scaling

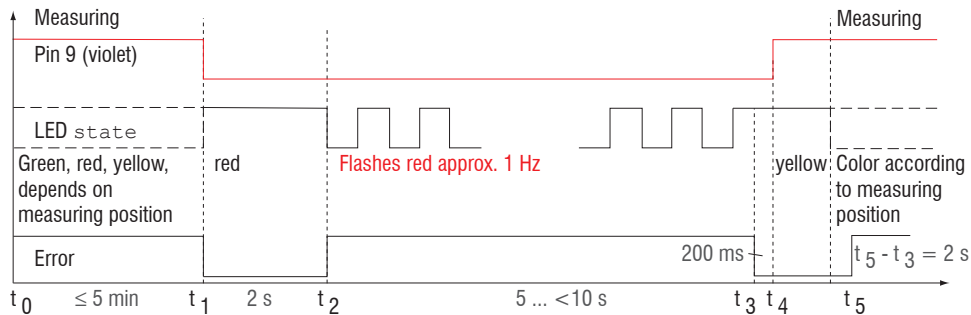

Fig. 40 Flow chart for the return of output scaling

7.5.3.4 Calculation of Measuring Value using Analog Current

Current output (without mastering, without teaching)

Variables	Value range	Formula
I_{OUT} = current [mA]	[3,8; <4] SMR reserve [4; 20] measuring range [>20; 20,2] EMR reserve	$d \text{ [mm]} = \frac{(I_{OUT} \text{ [mA]} - 4)}{16} * MR \text{ [mm]}$
MR = measuring range [mm]	{10/25/50/100/200/500}	
d = distance [mm]	[-0,01MR; 1,01MR]	

Current output (with mastering), reference value is midrange

Variables	Value range	Formula
I_{OUT} = current [mA]	[3,8; <4] SMR reserve [4; 20] measuring range [>20; 20,2] EMR reserve	$d \text{ [mm]} = \frac{(I_{OUT} \text{ [mA]} - 12)}{16} * MR \text{ [mm]}$
MR = measuring range [mm]	{10/25/50/100/200/500}	
MP = master position [mm]	[0; MR]	
d = distance [mm]	for $MP \leq 0.5MR$: [-MP; 0.5MR]	
	for $MP > 0.5MR$: [-0.5MR; MR - MP]	

Current output (with teaching)

Variables	Value range	Formula
I_{OUT} = current [mA]	[3,8; <4] SMR reserve [4; 20] measuring range [>20; 20,2] EMR reserve	$d [\text{mm}] = \frac{(I_{OUT} [\text{mA}] - 4)}{16} * n [\text{mm}] - m [\text{mm}] $
MR = measuring range [mm]	{10/25/50/100/200/500}	
m, n = teaching area [mm]	[0; MR]	
d = distance [mm]	[m ; n]	

Current output (with mastering and teaching)

Variables	Value range	Formula
I_{OUT} = current [mA]	[3,8; <4] SMR reserve [4; 20] measuring range [>20; 20,2] EMR reserve	$d [\text{mm}] = \frac{(I_{OUT} [\text{mA}] - 12)}{16} * n [\text{mm}] - m [\text{mm}] $
MR = measuring range [mm]	{10/25/50}	
MP = position object [mm]	[0; MR]	
m, n = teaching area [mm]	for $MP \leq 0.5MR$: [- MP ; 0.5 MR] for $MP > 0.5MR$: [-0,5 MR ; $MR - MP$]	
d = distance [mm]	[m ; n]	

7.5.3.5 Characteristics Distance Value and Analog Output

The mastering and zero setting function set the analog output on half of the output range independent on the master value, thus 12 mA. The examples below show the current output and the distance value behavior of an ILD1420-50 with 50 mm measuring range.

Target at 16 % measuring range

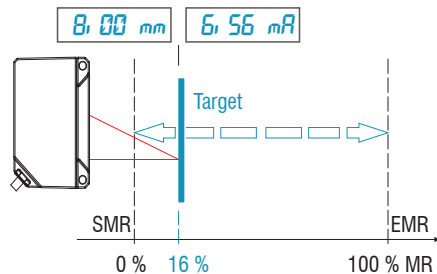
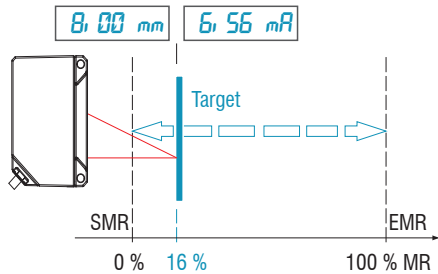

Target at 60 % measuring range

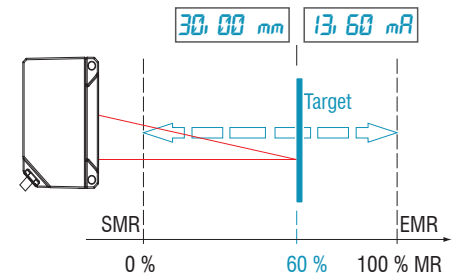

➡ Zero setting (master value = 0 mm)

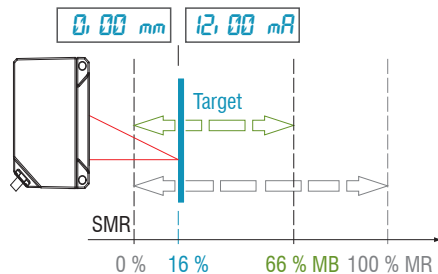

➡ Set master value 5 mm

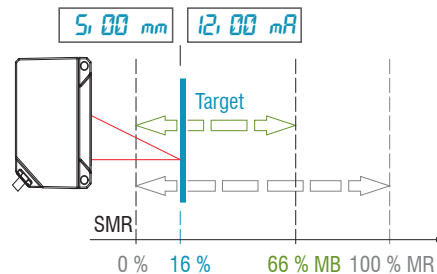

➡ Set master value 10 mm

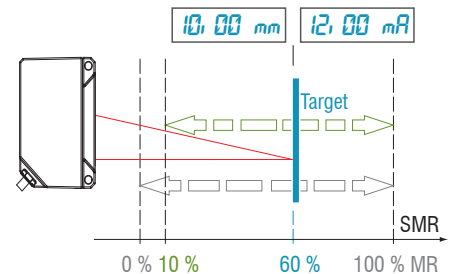

Analog maximum reached at 66 % MR

Analog minimum reached at 10 % MR

MR = measuring range, SMR = start of measuring range, EMR = end of measuring range

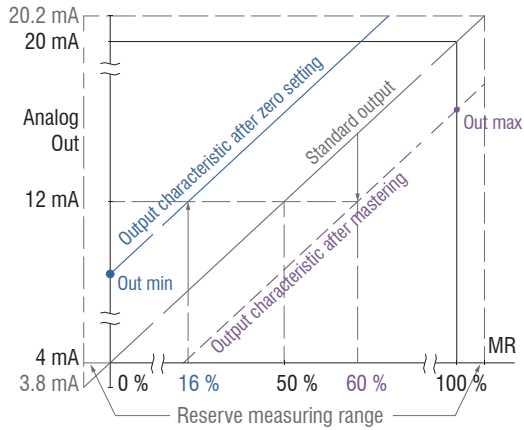

Master point	Master value	Out min	Out max
16 % (8 mm)	0 mm	9.44 mA (-8 mm)	20.0 mA (33 mm)
60 % (30 mm)	10 mm	4.00 mA (-15 mm)	18.40 mA (30 mm)

Fig. 41 Analog output with zero setting or mastering

7.5.3.6 Mastering and Teaching Analog Output

Proceed as follows:

1. Mastering or zero setting, menu `signal processing`
2. Teach putput, menu `Outputs`

The mastering and zero setting function set the analog output on half of the output range, see 7.5.3.5.

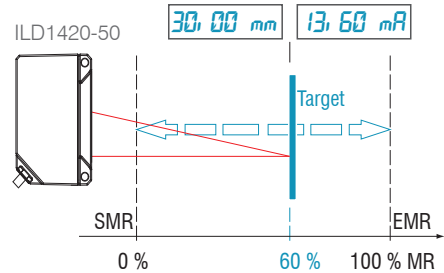

- ➡ Target at 60 %, set master value 0 mm
- ➡ Set minimum (m) 20 mm and maximum (n) 40 mm

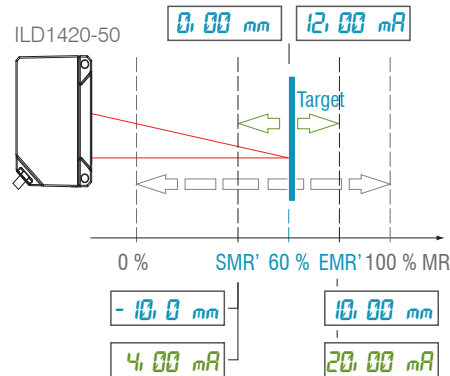

i With $n < m$ generates an inverse characteristic.

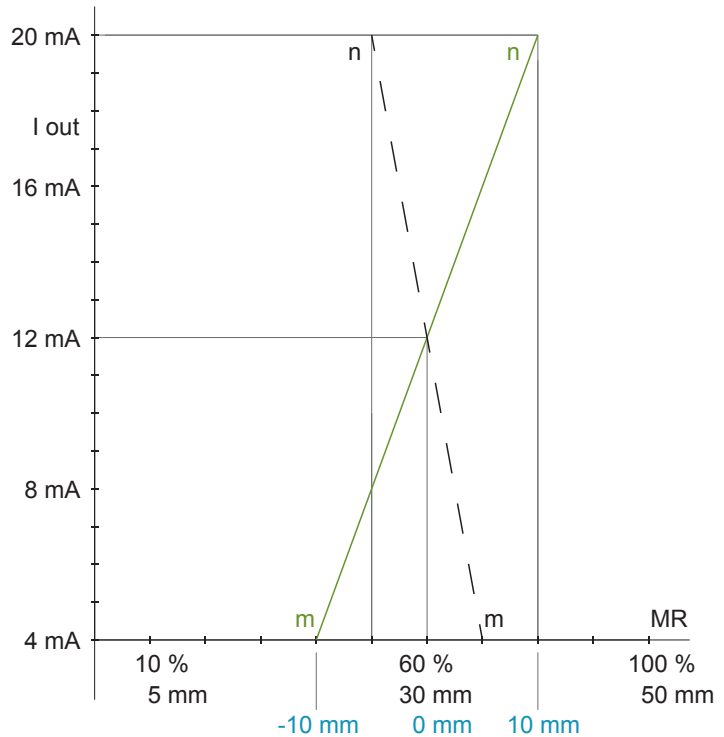

Fig. 42 Analog output characteristic after mastering and scaling with an ILD1420-50

7.6 System Settings

7.6.1 General

After programming all the settings are to be stored permanently in a set of parameters. The next time you turn on the sensor they are available again.

7.6.2 Unit, Language

The web interface promotes the units millimeter (mm) and inch when displaying measuring results.

You can choose German or English in the web interface. You can change language in the menu bar.

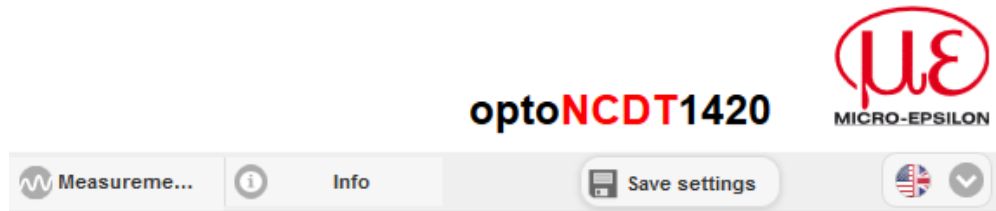



Fig. 43 Language selection in the menu bar

7.6.3 Keylock

The function keylock for the key `Select`, see 5.3, prevents unauthorized / unintended performing of the key functions. Keylock is always activated when user level `User` is chosen. Keylock can only be deactivated in user level `Expert`. If an expert logs in the system, keylock on the sensor is automatically unlocked.

Key lock	<i>Automatic</i>	<i>Range from 1 ... 60 [min]</i>	Value	<i>Keylock starts after expiry of defined time. Clicking the button <code>Refresh</code> prolongs the timeframe until keylock starts.</i>
	<i>Active</i>			<i>The key <code>Select</code> is deactivated independent of the user level.</i>
	<i>Inactive</i>			<i>The key <code>Select</code> is active independent of the user level.</i>

 Grey shaded fields require a selection.

 Value Dark-bordered fields require you to specify a value.

7.6.4 Load, Save

All settings to the sensor can be saved permanently in application programs, so called setups.

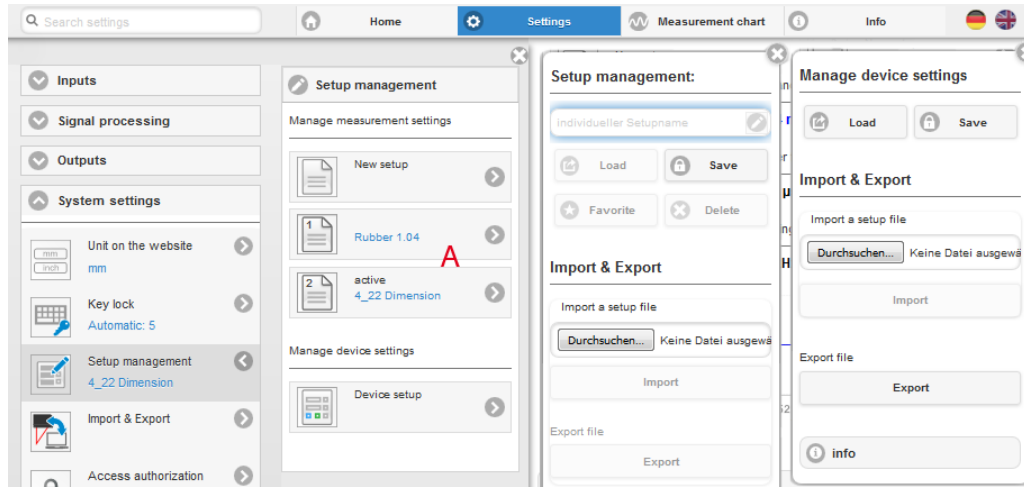
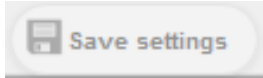

Fig. 44 Administration of application programs

Administer setups in the sensor, possibilities and procedure

Save settings	Activate existing setup	Save changes in active setup	Define setup after booting
Menu New setup	Menu Load & Save	Menu bar	Menu Load & Save
<p>➡ Enter the name for the setup into the field <input type="text" value="individueller Setupname"/> , e.g. rubber 1.21 and click the button Save.</p>	<p>➡ Click on the desired setup with the left mouse button, area A.</p> <p>The dialog Setup management opens.</p> <p>➡ Click on the button Load.</p>	<p>➡ Click on the button </p>	<p>➡ Click on the desired setup with the left mouse button, area A.</p> <p>The dialog Setup management opens.</p> <p>➡ Click on the button Favorite.</p>

Exchange setups with PC/notebook, possibilities	
Save setup on PC	Load setup from PC
Menu Load & Save	Menu Load & Save
<p>➡ Click on the desired setup with the left mouse button, area A.</p> <p>The dialog Setup management opens.</p> <p>➡ Click on the button Export.</p>	<p>➡ Click on Create setup with the left mouse button.</p> <p>The dialog Setup management opens.</p> <p>➡ Click on the button Search.</p> <p>A Windows dialog for file selections opens.</p> <p>➡ Choose the desired file and click on the button Open.</p> <p>➡ Click the button Import in the setup management.</p>

7.6.5 Import, Export

A set of parameters covers current settings, setup(s) and the initial setup when booting the sensor. The menu `Import & Export` enables easy exchange of sets of parameters with a PC/notebook.

Exchange set of parameters with PC/notebook, possibilities	
Save set of parameters on PC	Load set of parameters from PC
Menu <code>Import & Export</code>	Menu <code>Import & Export</code>
<p>➡ Click on the button <code>New set of parameters with the left mouse button</code>.</p> <p>The dialog <code>Choose setups for export</code> opens.</p> <p>➡ You arrange a set of parameters by selecting/deselecting the check boxes.</p> <p>➡ Click on the button <code>Transmit file</code>.</p> <p>A Windows dialog for file transmission opens.</p> <p>➡ Confirm the dialog with <code>OK</code>.</p> <p>The operating system stores the set of parameters in the area <code>Download</code>.</p> <p>File name for the following example is <code><...\Downloads\ILD1420_50BASICSETTINGS_Rubber 1.04..._.JSON></code></p>	<p>➡ Click on the button <code>Search</code>.</p> <p>A Windows dialog for file selection opens.</p> <p>➡ Choose the desired file and click on the button <code>Open</code>.</p> <p>The dialog <code>Choose setups for export</code> opens.</p> <p>➡ You define actions to be made by selecting/deselecting the check boxes.</p> <p>➡ Click on the button <code>Transmit file</code>.</p>

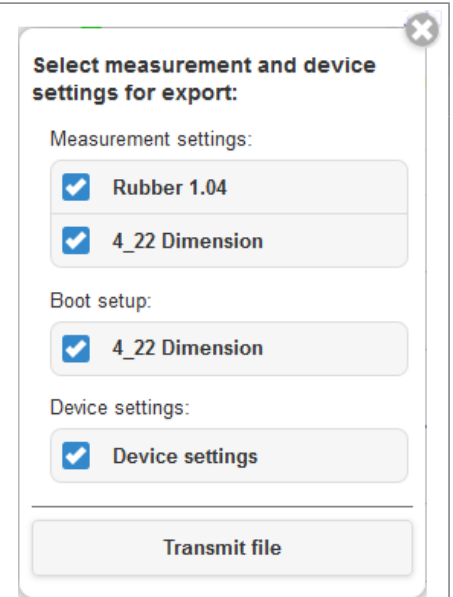

A security query, see adjacent figure, helps to avoid that an existing setup is inadvertently overwritten during import.

Options during import:

Overwrite existing setups (with the same name)
 Apply settings of the imported boot setup

7.6.6 Access Authorization

The assignment of a password prevents unauthorized changing of settings on the sensor. When delivered, the password protection is not enabled. The sensor operates in the user level `Professional`. The password protection should be enabled after configuration of the sensor. The default password for the expert level is `000`.

i The default password or a user-defined password is not changed by a software update. The professional password is independent of the setup and is therefore not together loaded or saved with the setup.

The following functions are available for the user:

	User	Professional
Password required	no	yes
Viewing settings, signal processing, outputs, system settings	yes	yes
Changing settings, signal processing, outputs, system settings	no	yes
Changing password	no	yes
Changing between the measurement and video signal chart types	no	yes
Scaling diagrams	yes	yes
Setting factory setting	no	yes

Fig. 45 Rights in the user hierarchy

Type in the default password `000` or a user-defined password in the `Password` field and confirm with `Login`.

Change with a click on the `Logout` button in the mode user.

Fig. 46 Change in the professional user level

The user management allows you to assign a custom password in the Professional mode.

Password	<i>Value</i>	<i>Case-sensitive rules are observed for all passwords. Numbers are allowed. Special characters are not allowed. Maximum length is set to 31 characters.</i>
User level when restarting	<i>User / Professional</i>	<i>Specifies the user level, with which the sensor starts after the re-starting. For this purpose, MICRO-EPSILON recommends the selection user.</i>

After configuration of the sensor the password protection is to be activated. Please note the password for later reference.

7.6.7 Sensor Reset

Sensor reset	Sensor settings	<i>Button</i>	<i>Settings for baud rate, language, unit, keylock and echo mode are deleted and the default parameters are loaded.</i>
	Measurement settings	<i>Button</i>	<i>Settings for measuring rate, trigger, evaluation range, peak selection, error handling, averaging, zeroing/mastering, data reduction and the setups are deleted. The 1st preset will be loaded.</i>
	Reset all	<i>Button</i>	<i>When clicking this button settings for sensor, measuring preferences, access authorization, password and the setups are deleted. The 1st preset will be loaded.</i>
	Restart sensor	<i>Button</i>	<i>When clicking this button the sensor is rebooted with the settings from the setup Favorite, see 7.6.4.</i>

 Grey shaded fields require a selection.

 Value Dark-bordered fields require you to specify a value.

8. Digital Interfaces RS422

8.1 Preliminary Remarks

The interface RS422 has a maximum baud rate of 1 MBaud. The factory-set baud rate is 921.6 kBaud.

Data format: Measurement values in binary format, commands as an ASCII string, Little Endian.

Interface parameter: 8 Data bits, no parity, one stop bit (8N1).

I Disconnect or connect the D-sub connection between RS422 and USB converter when the sensor is disconnected from power supply only.

8.2 Measurement Data Format

Up to 18 bits per output value are transmitted, [see 8.4](#). An output value is divided into three bytes that differ in the two most significant bits. The transmission of additional output values is optional.

Output value 1:

	Preamble		Data bits					
L-Byte	0	0	D5	D4	D3	D2	D1	D0
M-Byte	0	1	D11	D10	D9	D8	D7	D6
H-Byte	1	0	D17	D16	D15	D14	D13	D12

Output value 2 ... 32:

	Preamble		Data bits					
L-Byte	0	0	D5	D4	D3	D2	D1	D0
M-Byte	0	1	D11	D10	D9	D8	D7	D6
H-Byte	1	1	D17	D16	D15	D14	D13	D12

Output sequence: L-Byte, M-Byte, H-Byte.

Depending on the measuring rate, baud rate and output data rate, all output data can be output in one block. If the output is not possible, a runtime error is issued. Data selection and output sequence is to be queried with the GETOUTINFO_RS422 command.

The output of distance measurement value and other measurement value via RS422 requires a subsequent conversion into the corresponding unit, [see 8.4](#).

8.3 Conversion of the Binary Data Format

For conversion purposes the H-Byte, M-Byte and L-Byte must be identified on the basis of the two first bits (flag bits), the flag bits deleted and the remaining bits compiled into a 16 or 18 bit data word.

Result of conversion:



Conversion must be done in the application program. D16 and D17 are among others used for interpretation of error codes or e.g. for the measurement counter.

i The sensor continues to deliver measurement values to the RS422 output even while communicating with the sensor.

8.4 Values, Ranges

The digital measuring values are being output as unsigned digital values (raw values). 16 or 18 bits per value are being transmitted. Subsequently you can find a compilation of output values and the conversion of the digital value.

Value	Length	Variables	Value range	Formula
Distance (without mastering)	16 bits	x = digital value	[0; <643] SMR reserve [643; 64887] measuring range >64887; 65520] EMR reserve	$d \text{ [mm]} = \frac{1}{100} \left(\frac{102}{65520} x - 1 \right) * MR \text{ [mm]}$
		MR = measuring range [mm]	{10/25/50/100/200/500}	
		d = distance [mm]	[-0,01MR; 1,01MR]	
Distance (with mastering)	18 bits	x = digital value		The output range is also coded with 64235 values at 18 bit and shifted with the master value, see Fig. 48. The reserves at SMR and EMR are coded with 643 values each. $d \text{ [mm]} = \frac{1}{100} \left(\frac{102}{65520} x - 51 \right) * MR \text{ [mm]}$
		MR = measuring range [mm]	{10/25/50/100/200/500}	
		MP = master position [mm]	[0; MR]	
		MV = master value [mm]	[0; 2MR]	
		d = distance [mm]		
		$MV < MP - 0.5MR$:	[-0.5MR + MV; MR - MP + MV]	
$MV \geq MP - 0.5MR$:	[-MP + MV; MR - MP + MV]			
Exposure time	18 bits	x = digital value	[1; 262143]	$ET \text{ [\mu s]} = \frac{1}{10} x$
		ET = exposure time [μs]	[0.1; 26214.3]	
Intensity	16 bits	x = digital value	[0; 65472]	$I \text{ [%]} = \frac{25}{16368} x$
		I = intensity [%]	[0; 100]	

Sensor status	18 bits	x = digital value	[0; 242143]	Bit 0 (LSB): peak starts before ROI
		Bit encoding	[0; 1]	Bit 1: peak ends after ROI
				Bit 2: no peak found
		SMR = Start of measuring range		Bit 5: distance before SMR (extended)
		EMR = End of measuring range		Bit 6: distance after EMR (extended)
				Bit 15: measuring value is triggered
			Bit 16, 17: status LED; - 00 – off 10 – red - 01 – green 11 – yellow	
Measurement counter	18 bits	x = digital value	[0; 262143]	
Time stamp	2 words, at 16 bit	x = digital value Lo	[0; 65535]	t [ms] = $\frac{1}{100} (65536y + x)$
		y = digital value Hi	[0; 65535]	
		t = time stamp [ms]	[0; 11h55m49.67s]	
Non-linearized center of gravity	18 bits	x = digital value	[0; 262143]	CG [%] = $\frac{100}{262143} x$
		CG = center of gravity	[0; 100]	
Video raw signal	16 bits	512 pixel	[0; 65535]	

Additional information transmitted in the distance value

Distance value	Description
262075	data amount to big for selected baud rate
262076	no peak available
262077	peak before the measurement range (MR)
262078	peak behind the measurement range (MR)
262080	measurement can not be evaluated, global error
262081	peak is to large
262082	Laser is off

8.5 Characteristics Digital Output

Measurements are coded with 18 bit, if the based on zero setting or mastering. The master value itself can accept the double measuring range. The examples below show the digital output behavior of an ILD1420-50 with 50 mm measuring range.

Target at 16 % measuring range

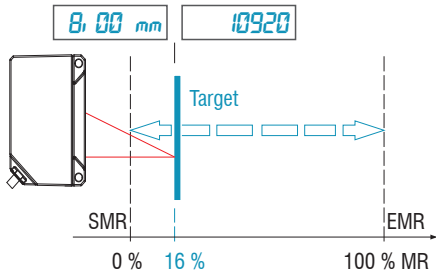

Target at 60 % measuring range

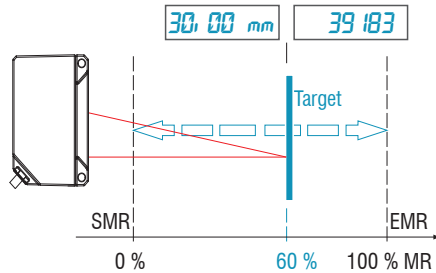

Target at 60 % measuring range

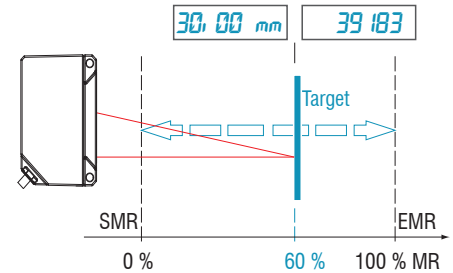

➡ Zero setting (master value = 0 mm)

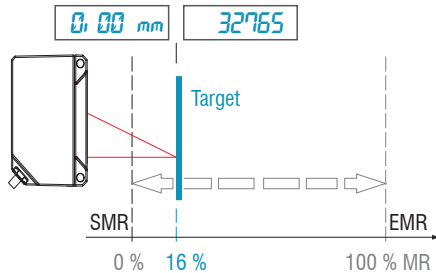

➡ Zero setting (master value = 0 mm)

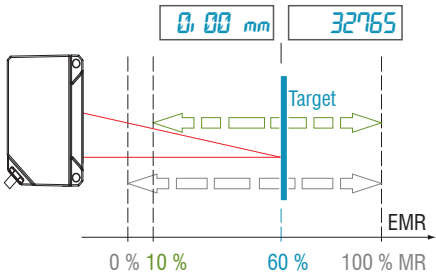

➡ Set master value 10 mm

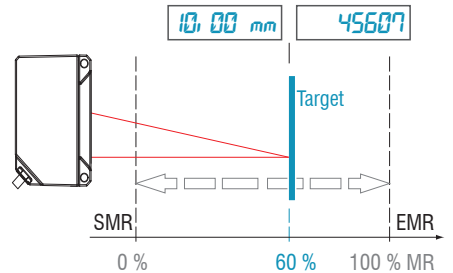

Digital minimum reached at 10 % MR

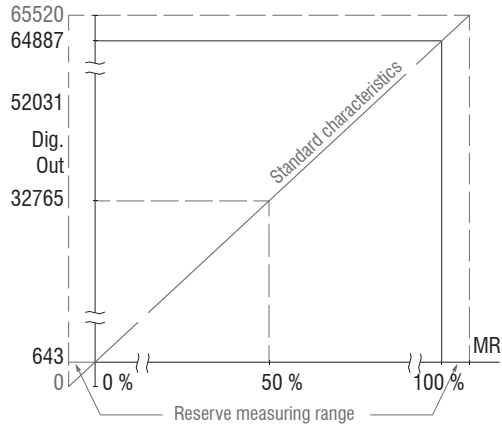

Fig. 47 Digital values without zero setting or mastering

➡ Set target at 80 % measuring range (40 mm), set master value 100 mm

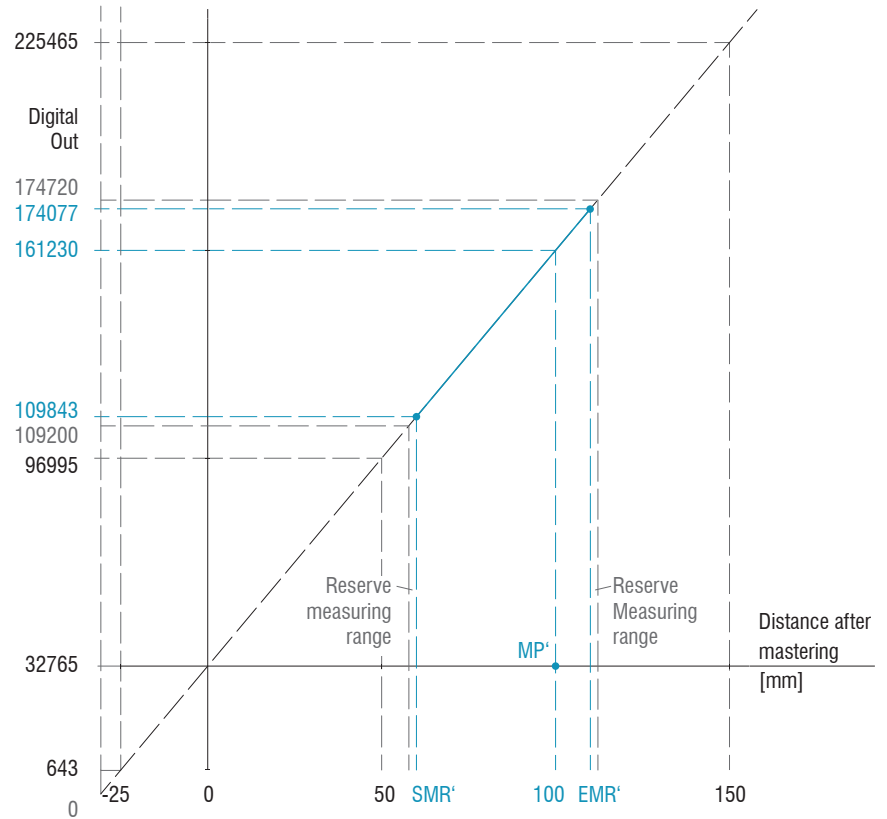



Fig. 48 Digital values of an ILD1420-50 with mastering, master value 100 mm

9. Cleaning

Cleaning of the protective screens is recommended periodically.

Avoid unnecessary laser radiation to be exposed to the human body.

 Switch off the sensor for cleaning and maintenance.

Dry Cleaning

Therefore an optics anti-static brush is suitable or bleeding the screen with dehumidified, clean and oil-free compressed air.

Wet Cleaning

For cleaning the protective screen use a clean, soft, lint-free cloth or lens cleaning paper with pure alcohol (isopropyl).

Never use standard glass cleaner or other cleaning agents.

10. Software Support with MEDAQLib

MEDAQLib offers you a documented driver DLL. Therewith you embed optoNCDT laser sensors, in combination with

- with the single channel IF2001/USB converter for RS422/USB or
- with the 4-fold IF2004/USB converter for RS422/USB and the PCF1420-x/IF2008 (IF2008-Y) connection cable or
- the PCI interface card IF 2008 and connection cable PCF1420-x/IF2008 and IF2008-Y-adapter cable

into an existing or a customized PC software.

MEDAQLib

- contains a DLL, which can be imported into C, C++, VB, Delphi and many additional programs,
- makes data conversion for you,
- works independent of the used interface type,
- features by identical functions for the communication (commands),
- provides a consistent transmission format for all MICRO-EPSILON sensors.

For C/C++ programmers MEDAQLib contains an additional header file and a library file.

You will find the latest driver/program routine at:

www.micro-epsilon.com/service/download

www.micro-epsilon.com/link/software/medaqlib

11. Disclaimer

All components of the device have been checked and tested for functionality in the factory. However, should any defects occur despite careful quality control, these shall be reported immediately to MICRO-EPSILON or to your distributor / retailer.

MICRO-EPSILON undertakes no liability whatsoever for damage, loss or costs caused by or related in any way to the product, in particular consequential damage, e.g., due to

- non-observance of these instructions/this manual,
- improper use or improper handling (in particular due to improper installation, commissioning, operation and maintenance) of the product,
- repairs or modifications by third parties,
- the use of force or other handling by unqualified persons.

This limitation of liability also applies to defects resulting from normal wear and tear (e.g., to wearing parts) and in the event of non-compliance with the specified maintenance intervals (if applicable).

MICRO-EPSILON is exclusively responsible for repairs. It is not permitted to make unauthorized structural and / or technical modifications or alterations to the product. In the interest of further development, MICRO-EPSILON reserves the right to modify the design.

In addition, the General Terms of Business of MICRO-EPSILON shall apply, which can be accessed under Legal details | Micro-Epsilon <https://www.micro-epsilon.com/impressum/>.

For translations into other languages, the German version shall prevail.

12. Service, Repair

If the sensor or sensor cable is defective:

- If possible, save the current sensor settings in a parameter set, [see 7.6.4](#), to reload them into the sensor after the repair.
- Please send us the affected parts for repair or exchange.

If the cause of a fault cannot be clearly identified, please send the entire measuring system to:

MICRO-EPSILON MESSTECHNIK
GmbH & Co. KG
Koenigbacher Str. 15
94496 Ortenburg / Germany

Tel. +49 (0) 8542 / 168-0
Fax +49 (0) 8542 / 168-90
info@micro-epsilon.com
www.micro-epsilon.com

13. Decommissioning, Disposal

In order to avoid the release of environmentally harmful substances and to ensure the reuse of valuable raw materials, we draw your attention to the following regulations and obligations:

- Remove all cables from the sensor and/or controller.
- Dispose of the sensor and/or the controller, its components and accessories, as well as the packaging materials in compliance with the applicable country-specific waste treatment and disposal regulations of the region of use.
- You are obliged to comply with all relevant national laws and regulations.





For Germany / the EU, the following (disposal) instructions apply in particular:

- Waste equipment marked with a crossed garbage can must not be disposed of with normal industrial waste (e.g. residual waste can or the yellow recycling bin) and must be disposed of separately. This avoids hazards to the environment due to incorrect disposal and ensures proper recycling of the old appliances.
- A list of national laws and contacts in the EU member states can be found at https://environment.ec.europa.eu/topics/waste-and-recycling/waste-electrical-and-electronic-equipment-weee_en. Here you can inform yourself about the respective national collection and return points.
- Old devices can also be returned for disposal to MICRO-EPSILON at the address given in the imprint at <https://www.micro-epsilon.com/impressum/>.
- We would like to point out that you are responsible for deleting the measurement-specific and personal data on the old devices to be disposed of.
- Under the registration number WEEE-Reg.-Nr. DE28605721, we are registered at the foundation Elektro-Altgeräte Register, Nordostpark 72, 90411 Nuremberg, as a manufacturer of electrical and/or electronic equipment.



Appendix

A 1 Optional Accessories

IF2001/USB	 <p>The image shows a white printed circuit board (PCB) for an RS422/USB converter. It features a green terminal block on the left for RS422 connections and a USB Type-A port on the right. The board is held together by two blue plastic clips. Text on the board includes 'IF2001/USB Converter', 'RS422/USB', and 'Micro-Epsilon'.</p>	<p>Single channel RS422/USB converter RS422 to USB, type IF2001/USB, useable for cable PCF1420-x/I or PCF1420-x/U, inclusive driver, connections: 1 × female connector 10-pin (cable clamp) type Würth 691361100010, 1x female connector 6-pin (cable clamp) type Würth 691361100006</p>
IF2035-PROFINET	 <p>The image shows a white DIN rail interface module. It has a top-hat rail on the left side and a network port on the front. The module is labeled 'IF2035-PROFINET' and 'Micro-Epsilon'.</p>	<p>Interface module for PROFINET connection of a Micro-Epsilon sensor with RS485 or RS422 interface, suitable for PCF1420-x/I or PCF1420-x/U cables, top-hat rail housing, incl. GSDML file for software integration in the PLC</p>
IF2035-EIP	 <p>The image shows a white DIN rail interface module, similar to the IF2035-PROFINET model. It features a top-hat rail and a network port. The module is labeled 'IF2035-EIP' and 'Micro-Epsilon'.</p>	<p>Interface module for connection of Micro-Sensors with RS422/RS485 interface to Ethernet/IP 1-channel system with DIN rail housing Software integration into the PLC with EDS file Certified according to Ethernet/IP CT16</p>
IF2035-EtherCAT	 <p>The image shows a white DIN rail interface module, similar to the IF2035-PROFINET model. It features a top-hat rail and a network port. The module is labeled 'IF2035-EtherCAT' and 'Micro-Epsilon'.</p>	<p>Interface module for EtherCAT connection of a Micro-Epsilon sensor with RS485 or RS422 interface, suitable for PCF1420-x/I or PCF1420-x/U cables, top-hat rail housing, incl. ESI file for software integration in the PLC</p>
PS2020	 <p>The image shows a blue DIN rail power supply unit. It has a top-hat rail on the left side and a power output terminal on the right. The unit is labeled 'PULS' and 'PS2020'.</p>	<p>Power supply for mounting on DIN rail, input 230 VAC, output 24 VDC/2.5 A</p>

IF2004/USB



4-channel RS422/USB converter for one to four optical sensors with RS422 interface

Data output via USB interface

Power supply 24 VDC / 2 A is required for operation (not included).

C-Box/2A



Controlling two Micro-Epsilon sensors with RS422 interface suitable for PCF1420-x/C-Box cable, synchronous calculation of the two individual sensor signals is possible, converter from RS422 to USB/Ethernet, parameterization via web interface or ASCII commands

IF2008/PCIE

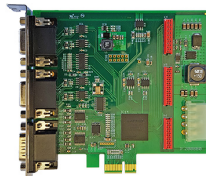

The IF2008/PCIE interface card enables the synchronous capture of 4 digital sensor signals series optoNCDT 1420 or others or 2 encoders. In combination with IF2008E a total of 6 digital signals, 2 encoder, 2 analog signals and 8 I/O signals can be acquired synchronously.

IF2008/ETH converter
RS422/Ethernet



8-fold RS422 to Ethernet converter with industrial M12 male/female connector for connection of up to 8 ILD1420, ILD1750, ILD1900, ILD2300 sensors or IFC2451/61 controller; additionally 4 programmable switching inputs and outputs, which can be addressed via TTL and HTL logic; permissible temperature range storage: +5 ... +50 °C; protection class IP65

IF2008-Y adapter cable



Used to connect two sensors with interface cable PCF1420-x/IF2008 to a port of the IF2008.

PCF1420-x/I



PCF1420-x/I Supply and output cable, 3 m, 6 m, 10 m

PCF1420-x/U



Supply and output cable; 3 m, 6 m, 10 m, 15 m lang
Sensor side 12-pin round plug, other side open ends,
output signal 1 - 5 volts for the measuring range of the sensor, drag-chain suitable

PCF1420-x/IF2008



Supply and output cable; 3 m, 6 m, 10 m

PCE1420-3/M12



Sensor extension cable for ILD1420 in connection with IF2008/ETH,
Length 3 m, one side with 12-pin socket overmolded one side with 12-
pin plug type Binder Series 713, drag-chain suitable

PCF1420-x/C-Box



Supply and output cable for connecting an ILD1420 to the C-Box/2A;
cable length $x = 3, 6, 8, 9$ or 10 m

A 2 Factory Setting

Password	„000“
Measuring rate	2 kHz
Measuring range	100 % FSO: I = 20 mA, digital 64887
	0 % FSO: I = 4 mA, digital 643
Peak selection	Highest peak
Error handling	Error output, no measurement

Measurement averaging	Median 9
Output	Analog current
RS422	921.6 kBaud
Trigger mode	No trigger
Language	German

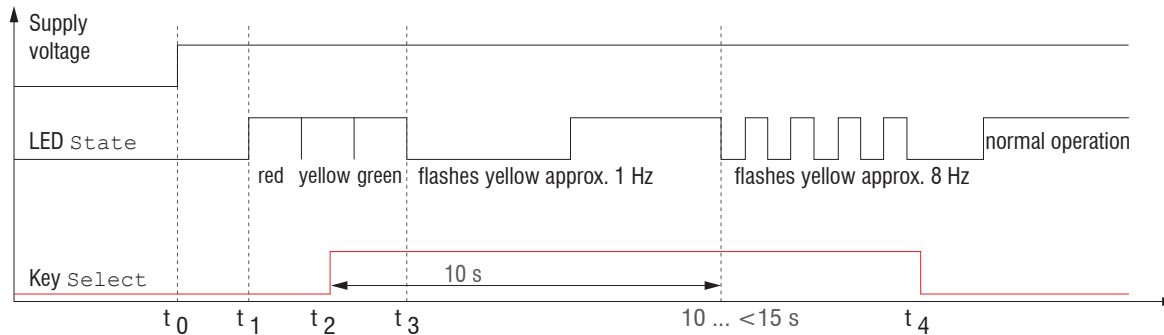

Fig. 49 Flow chart to start a sensor with factory setting

- t_0 : power supply is on
 - $t_1 \dots t_3$: both LEDs signalize the start sequence (red-yellow-green for 1 sec. each)
 - t_2 : key is pressed during start sequence ($t_1 \dots t_3$)
 - t_4 : key is released while the LED State is flashing yellow
- $\Delta t = t_4 - t_2$; Δt (key press period) must be at least 10 sec., max. 15 sec.

A 3 ASCII Communication with Sensor

A 3.1 General

The ASCII commands can be sent to the sensor via the RS422 interface. All commands, inputs and error messages are effected in English.

One command always consists of a command name and zero or several parameters, which are separated by blanks and are completed with LF. If blanks are used in parameters, the parameter must be set in quotation marks.

Example: Switch on the output via RS422

OUTPUT RS422 ←↵

Advice: ←↵ must include LF, but may also be CR LF.

Declaration: LF Line feed (line feed, hex 0A)

CR Carriage return (carriage return, hex 0D)

←↵ Enter (depending on the system System hex 0A or hex 0D0A)

The currently set parameter value is returned, if a command is activated without parameters.

The input formats are:

```
<Command name> <Parameter1> [<Parameter2> [...]]
```

```
<Command name> <Parameter1> <Parameter2> ... <Parameter...>
```

or a combination thereof.

Parameters in []-brackets are optional and require the input of the parameter standing in front. Sequent parameters without []-brackets are to input compulsory, that is, it must not be omitted a parameter.

Alternative inputs of parameter values are displayed separately by „|“, for example the values „a“, „b“ or „c“ can be set for „a|b|c“.

Parameter values in <> brackets are selectable from a value range.

Declarations on format:

„a b“	Value of the parameter can be set to the value “a” or “b”.
„ P1 P2“	It requires that both parameters “P1” and “P2” are set.
„ P1 [P2 [P3]]“	The parameters “P1”, “P2” and “P3” can be set, whereby “P2” may only be set, if “P1” is set and “P3” only if “P1” and “P2” are set.

„<a>“	The value of the parameter lies in a value range of “... to ...“, see parameter description.
-------	--

Parameter values without peak brackets can only assume discrete values, see parameter description.

Parantheses are to be understood as a grouping, that is, for a better articulation „P1 P2 | P3“ is written as „(P1 P2)|P3“.

Example without []:

„PASSWD <Old password> <New password> <New password>“

- To change the password, all three parameters are to be input.

The output format is:

<Command name> <Parameter1> [<Parameter2> [...]]

The reply can be used again as command for the parameter setting without changes. Optional parameters are only returned, if the returning is necessary. For example, the activated output values are returned by command Data selection additional values. After processing a command always a return and a prompt (“->“) is returned. In the case of an error an error message is before the prompt, that begins with „Exxx“, where xxx is a unique error number. Also warnings („Wxxx“) can be output instead of error messages.

These are analogous to the error messages. In case of warnings the command is executed.

The replies to the commands GETINFO and PRINT are useful for support requests to the sensor, because they contain sensor settings.

A 3.2 Overview Commands

Group	Chapter	Command	Short description
General			
	Chap. A 3.3.1	HELP	Help on commands
	Chap. A 3.3.2	GETINFO	Request sensor information
	Chap. A 3.3.3	LANGUAGE	Determine language of website
	Chap. A 3.3.4	RESET	Reboot sensor
	Chap. A 3.3.5	RESETCNT	Reset counter
	Chap. A 3.3.6	ECHO	Switching the command reply, ASCII interface
	Chap. A 3.3.7	PRINT	Output of all sensor settings
User level			
	Chap. A 3.3.8.1	LOGIN	Change of user level
	Chap. A 3.3.8.2	LOGOUT	Change to user in the user level
	Chap. A 3.3.8.3	GETUSERLEVEL	User level request
	Chap. A 3.3.8.4	STDUSER	Setting the standard user
	Chap. A 3.3.8.5	PASSWD	Change password
Triggering			
	Chap. A 3.3.9.1	TRIGGER	Selection of trigger mode
	Chap. A 3.3.9.2	TRIGGERAT	Effect of the trigger input
	Chap. A 3.3.9.3	MFILELEVEL	Selection of level for multifunctional input
	Chap. A 3.3.9.4	TRIGGERCOUNT	Number of measurement values displayed
	Chap. A 3.3.9.5	TRIGGERSW	Software - trigger pulse

Interfaces			
	Chap. A 3.3.10.1	BAUDRATE	RS422 setting
	Chap. A 3.3.10.2	UNIT	Selection of measuring unit web interface
	Chap. A 3.3.10.3	MFIFUNC	Selection of function multifunctional input
	Chap. A 3.3.10.4	ERROROUT1	Activate digital output
	Chap. A 3.3.10.5	ERRORLEVELOUT1	Output level digital output
	Chap. A 3.3.10.6	ERRORLIMIT	Limit to activate digital output
	Chap. A 3.3.10.7	ERRORHYSTERESIS	Stable digital output
	Chap. A 3.3.10.8	ERROROUTHOLD	Minimum duration active digital output
Handling of setups			
	Chap. A 3.3.11.1	IMPORT	Load parameter
	Chap.	EXPORT	Export sensor settings
	Chap. A 3.3.11.2	MEASSETTINGS	Load/save measurement settings
	Chap. A 3.3.11.3	BASICSETTINGS	Load/save device settings
	Chap. A 3.3.11.4	SETDEFAULT	Factory settings
Scaling of analog output			
	Chap. A 3.3.12	ANALOGSCALE	Scaling analog output
Key function			
	Chap. A 3.3.13.1	KEYFUNC	Selection of key function
	Chap. A 3.3.13.2	KEYLOC	Selection of keylock

Measurement			
	General		
	Chap. A 3.4.1	TARGETMODE	Choice of measurement algorithms
	Chap. A 3.4.2	MEASPEAK	Choice of the peak in the video signal
	Chap. A 3.4.3	MEASRATE	Selection of measuring rate
	Chap. A 3.4.4	LASERPOW	Selection of laser power
	Chap. A 3.4.5	ROI	Masking the region of interest
	Measurement Value Processing		
	Chap. A 3.4.6.1	AVERAGE	Selection of measurement averaging
	Chap. A 3.4.6.2	MASTERMV	Mastering / Zeroing
Data Output			
	General		
	Chap. A 3.5.1	OUTPUT	Selection measuring value output
	Chap. A 3.5.2	OUTREDUCEDEVICE	Selection of interface for data reduction
	Chap. A 3.5.3	OUTREDUCECOUNT	Reduces measurement value output
	Chap. A 3.5.4	OUTHOLD	Setting of error processing
	Select measurement values to be output		
	Chap. A 3.5.5.1	GETOIUTINFO_RS422	Request data selection
	Chap. A 3.5.5.2	OUTADD_RS422	Selection of additional values
	Chap. A 3.5.5.3	OUTVIDEO_RS422	Stop video output

A 3.3 General Commands

A 3.3.1 HELP

```
HELP [<Command>]
```

Issues a help for every command. If no command is specified, a general help is output.

A 3.3.2 GETINFO, Sensor Information

```
GETINFO
```

Request of sensor information. Output see example below:

```
->GETINFO
Name:           ILD1420-10           //Model name sensor, sensor series
Serial:         15030002             //Serial number
Option:         000                  //Option number of sensor
Article:        4120212             //Article number of sensor
Cable head:     Wire
Measuring range: 10.00mm            //Measuring range of sensor
Version:        001.010             //Version of software
Hardware-rev:   00
Boot-version:   001.000
->
```

A 3.3.3 LANGUAGE, Website

```
LANGUAGE DE | EN | CN
```

Determines the language for the web interface.

- DE: set language to German
- EN: set language to English
- CN: set language to Chinese

The chosen language setting applies to the website.

A 3.3.4 RESET, Boot Sensor

RESET

The sensor is rebooted.

A 3.3.5 RESETCNT, Reset Counter

RESETCNT [TIMESTAMP] [MEASCNT]

Sets back internal counters in the sensor.

- TIMESTAMP: sets back timestamp
- MEASCNT: sets back measurement counter

A 3.3.6 ECHO, Switching the Command Reply, ASCII Interface

ECHO ON|OFF

Setting the command reply with a ASCII command:

- ON: command reply on, for example <Kdo> ok (or notice of error)
->
- OFF: command reply off, for example ->

A 3.3.7 PRINT, Sensor Settings

PRINT

Print serves the output of all sensor settings.

Example of an answer:

```
GETUSERLEVEL PROFESSIONAL      OUTPUT ANALOG
STDUSER PROFESSIONAL          OUTREDUCEDEVICE NONE
BAUDRATE 921600              OUTREDUCECOUNT 2
UNIT MM                       OUTVIDEO_RS422 NONE
LANGUAGE DE                   OUTADD_RS422 NONE
MFIFUNC NONE                  GETOUTINFO_RS422 DIST1
MFILEVEL HTL_HIGH            OUTHOLD NONE
KEYFUNC NONE                  ERROROUT1 DIST
KEYLOCK AUTO 5 (IS_ACTIVE)    ERRORLEVELOUT1 NPN
TARGETMODE STANDARD          ANALOGSCALE STANDARD
MEASRATE 2.000
MEASPEAK DISTA               ->
ROI 0 511
AVERAGE MEDIAN 9
TRIGGERAT INPUT
TRIGGER NONE
TRIGGERCOUNT INFINITE
LASERPOW FULL
MASTERMV NONE
```

A 3.3.8 User Level

A 3.3.8.1 LOGIN, Change of the User Level

```
LOGIN <Password>
```

Enter the password to change user level. The following user levels are available:

- USER (standard user): “read-only” access to all elements and graphical display of output values of web surface
- PROFESSIONAL (expert): “read-only” and “write” access to all elements

A 3.3.8.2 LOGOUT, Change into User Level

```
LOGOUT
```

Set user level to USER.

A 3.3.8.3 GETUSERLEVEL, User Level Request

```
GETUSERLEVEL
```

Request current user level

A 3.3.8.4 STDUSER, Set Standard User

```
STDUSER USER|PROFESSIONAL
```

Set standard user who is automatically logged in after system start. Standard user does not change with LOGOUT which means login as standard user is done automatically after the command RESET or power supply of sensor is switched on.

A 3.3.8.5 PASSWD, Change Password

```
PASSWD <Old Password> <New password> <New password>
```

Change password for user level PROFESSIONAL.

Type in the old password followed by the new password (2x). In case the new password is not typed in correctly, an error message is will be displayed.

Password may only contain letters from A to Z, no numbers 0 to 9. Watch upper and lower case lettering.

The maximum length is limited to 31 characters.

A 3.3.9 Triggering

The multifunctional input also serves as trigger input.

A 3.3.9.1 TRIGGER, Selection

```
TRIGGER NONE | EDGE | PULSE | SOFTWARE
```

- NONE: no triggering
- PULSE: level triggering
- EDGE: edge triggering
- SOFTWARE: software triggering

A 3.3.9.2 TRIGGERAT, Effect of the Trigger Input

```
TRIGGERAT INPUT | OUTPUT
```

- INPUT: triggers the measurement value recording. Measurement values immediately before the trigger event are not included when calculating the mean value. Instead, older values are used which were output during previous trigger events.
- OUTPUT: triggers the measurement value output. Measurement values immediately before the trigger event are included when calculating the mean.

A 3.3.9.3 MFILELEVEL, Input Pulse Multifunctional Input

```
MFILELEVEL HTL_HIGH | HTL_LOW
```

Selection of switching or trigger level for the multifunctional input.

- HTL_HIGH: high active (edge triggering: rising edge, pulse triggering: high active)
- HTL_LOW: low active (edge triggering: falling edge, pulse triggering: low active)

A 3.3.9.4 TRIGGERCOUNT, Number of Displayed Measurement Values

```
TRIGGERCOUNT NONE | INFINITE | <n>
```

```
<1...16382>
```

Number of displayed measurement values while triggering

- NONE: stop triggering and start continuous output
- INFINITE: start continuous output after first trigger impulse
- <n>: number of displayed measurement values after each trigger impulse $n = 1 \dots 16382$

A 3.3.9.5 TRIGGERSW, Software Trigger Pulse

```
TRIGGERSW
```

Creates a trigger pulse. Error message is displayed if “SOFTWARE” is not selected in trigger selection.

A 3.3.10 Interfaces

A 3.3.10.1 BAUDRATE, RS422

```
BAUDRATE 9600|19200|56000|115200|128000|230400|256000|460800|691200|921600|  
1000000
```

Set the baud rate for the RS422 interface.

A 3.3.10.2 UNIT, Web Interface

```
UNIT MM|INCH
```

Change the measurement display on the websites. The command has no effect on the ASCII interface.

- MM representation in mm
- INCH representation in customs

A 3.3.10.3 MFIFUNC, Function Selection Multifunctional Input

```
MFIFUNC NONE | MASTER | TEACH | TRIGGER
```

Choose function of the multifunctional input.

- NONE: multifunctional input has no function
- MASTER: multifunctional input is master impulse input
- TEACH: multifunctional input is teach input for analog output
- TRIGGER: multifunctional input is trigger input

A 3.3.10.4 ERROROUT1, Activate Digital Output

```
ERROROUT1 NONE|DIST|TEACH|LI1
```

Choose error signal of the digital output.

- NONE: error ourput deactivated
- DIST: no peak found or beyond measuring range (out of range)
- TEACH: Distance is out of scaled analog range
- LI1: Distance is greater than the limit value (ERRORLIMIT)

A 3.3.10.5 ERRORLEVELOUT1, Output Level Digital Output

ERRORLEVELOUT1 NPN|PNP|PUSHPULL|PUSHPULLNEG

Choice of output level for ERROROUT1.

- NPN: digital output is active in case of an error
- PNP: digital output is active in case of an error
- PUSHPULL: digital output with high level in case of an error
- PUSHPULLNEG: digital output with low level in case of an error

Wiring of digital output ERROR1, [see 5.4.8](#).

A 3.3.10.6 ERRORLIMIT

ERRORLIMIT DIST1 <upper threshold>

Digital output is activated, if the defined value for a measurement is exceeded.

Range: 0 ... 2 * measuring range [mm].

A 3.3.10.7 ERRORHYSTERESIS

ERRORHYSTERESIS <hysteresis>

Digital output is deactivated, if the defined value for a measurement falls below the limit value.

Range: 0 ... 2 * measuring range [mm].

A 3.3.10.8 ERROROUTHOLD

ERROROUTHOLD <hold period>

Indicates in ms how long the digital output must be active at least when the limit value is exceeded. This time period starts when the limit value is exceeded. Range: 0 ... 1000 [ms].

A 3.3.11 Handling of Setups

A 3.3.11.1 IMPORT

```
IMPORT [FORCE] [APPLY] <Data>
```

Import of data in JSON format ¹ to the sensor.

First, the import command returns a prompt (->). Afterwards, data can be sent.

After importing a prompt (->) is returned.

- FORCE: overwriting of measurement settings (= MEASSETTINGS) with the same name (otherwise an error message is returned when using the same name). When importing all measurement settings or device settings (= BASICSETTINGS) FORCE must always be stated.
- APPLY: applying the settings after importing / reading of initial settings.

1) JSON format, see https://de.wikipedia.org/wiki/JavaScript_Object_Notation EXPORT

```
EXPORT ALL | MEASSETTINGS_ALL | (MEASSETTINGS <SetupName>) | BASICSETTINGS
```

Exporting sensor settings. As a response data is transmitted in JSON format. Finally a prompt occurs.

A 3.3.11.2 MEASSETTINGS, Load / Save Measurement Settings

```
MEASSETTINGS <Subcommands> [Name]
```

Settings of the measurement task.

Loads proprietary presets and user-specific settings from the sensor or stores user-specific setups in the sensor.

Subcommands:

- CURRENT: Output of the name of current measurement setting
- PRESETLIST: Listing of all existing presets (names): „Standard“, „Multi-Surface“, „Light Penetration“.
- LIST: Listing of all saved measurement settings (names) “Name1” “Name2” “...”.
- READ <Name>: Loads a preset or a measurement setting from the sensor.
- STORE <Name>: Saves the current measurement setting in the sensor.
- DELETE <Name>: Deletes a measurement setting
- RENAME <NameOld> <NameNew> [FORCE]: Renaming a measurement setting. An existing measurement setting can be overwritten with FORCE.
- INITIAL <name> | AUTO: Loads a named or last saved measurement setting at the start of the sensor. Presets can not be specified.

- PRESETMODE: Returns the set signal quality
- PRESETMODE <Mode>: Setting the signal quality. Setting the signal quality is possible only, if a preset was loaded.
 - <mode> = STATIC|BALANCED|DYNAMIC|NOAVERAGING|NONE

A 3.3.11.3 BASICSETTINGS, Load / Save Device Settings

```
BASICSETTINGS READ | STORE
```

- READ: Loads the stored device settings from the sensor.
- STORE: Saves the current device settings in the sensor.

A 3.3.11.4 SETDEFAULT, Default Settings

```
SETDEFAULT ALL | MEASSETTINGS | BASICSETTINGS
```

Sets sensor back to default settings.

- ALL: Measurement and device settings are being deleted. The standard preset for the measurement setting or the the default parameter for the device settings are being loaded.
- MEASSETTINGS: Measurement settings are being deleted and the standard preset is being loaded.
- BASICSETTINGS: Device settings are being deleted and the default parameters are being loaded.

A 3.3.12 ANALOGSCALE, Scaling the Analog Output

```
ANALOGSCALE STANDARD| (TWOPOINT <Minimum value> <Maximum value>)
```

Setting the two point scaling of the analog output.

- STANDARD: using the measuring range of the sensor
- TWOPOINT: two point scaling within the analog range (4 - 20 mA)
 - Minimum value: measurement value in mm which is matched to the lower analog value (4 mA)
 - Maximum value: measurement value in mm which is matched to the upper analog value (20 mA)

i The minimum value (in mm) can be higher than the maximum value (in mm), [see 7.5.3](#).

A 3.3.13 Key Function

A 3.3.13.1 KEYFUNC, Choose Key Function

```
KEYFUNC NONE | MASTER | TEACH
```

Choice of key function.

- NONE: key has no function
- MASTER: key is used for mastering
- TEACH: key is used for teaching

A 3.3.13.2 KEYLOCK, Set Keylock

```
KEYLOCK NONE|ACTIVE|AUTO <time>
```

Choice of keylock.

- NONE: key works permanently, no keylock
- ACTIVE: keylock is activated right after reboot
- AUTO: keylock is only activated <time> minutes after reboot

A 3.4 Measurement

A 3.4.1 TARGETMODE, Measurement Mode

```
TARGETMODE STANDARD|MULTISURFACE|PENETRATION 1
```

Choice of material dependent presets, [see 7.4.2](#).

- STANDARD: suitable for materials, e.g. made of ceramics, metal, plastics or wood
- MULTISURFACE: suitable for materials with changing surfaces, e.g. PCB or hybrid materials
- PENETRATION: suitable for materials with strong penetration depth of the laser light

A 3.4.2 MEASPEAK, Choice of the Peak in the Video Signal

```
MEASPEAK DISTA|DIST1|DISTL
```

- DISTA: output of peak with highest amplitude (standard)
- DIST1: output of first peak
- DISTL: output of last peak

1) Available for the sensor models ILD1420-10/25/50.

A 3.4.3 MEASRATE, Measuring Rate

```
MEASRATE 0.25|0.5|1|2|4|8
```

Choice of measuring rate in kHz.

A 3.4.4 LASERPOW, Laser Power

```
LASERPOW FULL|OFF
```

- FULL: laser power is set to 100 %
- OFF: laser is switched off

A 3.4.5 ROI, Video Signal, Masking the Region of Interest (ROI)

```
ROI <Start> <End>
```

Set “region of interest”. ROI for start and end is between 0 and 511. “Start” value is smaller than “End” value. For sensors with 500 mm measuring range this is a individually value < 511.

A 3.4.6 Measurement Value Processing

A 3.4.6.1 AVERAGE, Measurement Value

```
AVERAGE NONE|(MOVING|RECURSIVE|MEDIAN [<Averaging depth>])
```

Averaging affects the displacement value to be output.

- MOVING: Moving averaging value (averaging depth 2, 4, 8, 16, 32, 64 and 128 possible)
- RECURSIVE: Recursive averaging value (averaging depth 2 up to 32767 possible)
- MEDIAN: Median (averaging depth 3, 5, 7 and 9 possible)

A 3.4.6.2 MASTERMV, Mastering / Zeroing

```
MASTERMV NONE|MASTER <MV>
```

- NONE: completes mastering
- MASTER: sets the current measurement value as a master value
- MV: master value in millimeters; $MV = (0 \dots 2) * \text{measuring range}$, i.e. master value must be within measuring range

In case of master value is 0, the mastering has the same functionality as the zeroing. The parameter MV always operates independently from an input as zeroing during mastering the analog output.

The master command awaits the next measurement value, a maximum of 2 seconds, and masters it. If no measurement value is received within this time, for example, by external triggering, the command returns with the error "E220 Timeout".

The master value is processed with six decimal places.

Note that the output value is limited to 18 bits.

A 3.5 Data Output

A 3.5.1 OUTPUT, Selection of Measurement Value Output

```
OUTPUT NONE|RS422|ANALOG
```

- NONE: no measurement value
- RS422: output of measurement value via RS422
- ANALOG: analog output of measurement values

A 3.5.2 OUTREDUCEDEVICE, Output Reduction of Measurement Value Output

```
OUTREDUCEDEVICE NONE| ([RS422] [ANALOG])
```

Selection of interface for data reduction.

- NONE: no data reduction
- RS422: data reduction for RS422
- ANALOG: data reduction for analog output

A 3.5.3 OUTREDUCECOUNT, Output Data Rate

```
OUTREDUCECOUNT <n>
```

Reduces measurement value output of the chosen interfaces.

- 1: outputs each measurement value
- 2 ... 3000000: output of each n-th measurement value

A 3.5.4 OUTHOLD, Error Processing

```
OUTHOLD NONE|INFINITE|<n>
```

Setting the behavior of the measurement value output in case of error.

- NONE: no holding of the last measurement value, output of error value
- INFINITE: infinite holding of the last measurement value
- <n>: holding of the last measurement value on the number of measurement cycles; then an error value is output
n = (1 ... 1024)

A 3.5.5 Selection of Measurement Values to be Output

A 3.5.5.1 GETOUTINFO_RS422, Request Data Selection

```
GETOUTINFO_RS422
```

The command lists all selected output data for the RS422 interface. The sequence shown corresponds to the output sequence.

A 3.5.5.2 OUTADD_RS422, Selection of Data Additional Values

```
OUTADD_RS422 NONE| ([SHUTTER] [COUNTER] [TIMESTAMP] [INTENSITY] [STATE]  
[DIST_RAW])
```

Selection of additional values to be transmitted.

- NONE: no output of additional values
- SHUTTER: output of exposure time
- COUNTER: output of measurement value counter
- TIMESTAMP: output of timestamp
- INTENSITY: output of intensity parallel to each distance value
- STATE: output of status word
- DIST_RAW: output of uncalibrated distance value (raw value)

A 3.5.5.3 OUTVIDEO_RS422, Adjust Video Output

```
OUTVIDEO_RS422 NONE|VIDEO_RAW
```

Defines the data to be transmitted at a video image transmission via RS422.

- NONE: no video images
- VIDEO_RAW: output of uncorrected video signal (raw signal)

A 3.6 Example Command Sequence During Selection of Measurement Value

Command	Content
MEASPEAK	Peak selection for displacement measurement
MEASRATE	Measuring rate (under consideration of reflectivity and movement of the target)
AVERAGE	Averaging of the measurement value (under consideration of reflectivity, structure and movement of the target)
OUTPUT	Selection of the output channel
OUTREDUCEDEVICE	Reduction of the output data rate (under consideration of the chosen output channel, its settings and the processing range of the target system)
OUTREDUCECOUNT	
OUTHOLD	Output characteristic during measurement errors
OUTADD_RS422	Selection of the additional values to be output for RS422 interface
BAUDRATE	Baud rate settings RS422 interface

A 3.7 Error Messages

If an error occurs with a command, the error message is listed.

Error message	Description
E100 Internal error	Internal error code
E104 Timeout	Timeout while mastering.
E200 I/O operation failed	Cannot write data to the output channel.
E202 Access denied	Access denied: Login as expert is necessary.
E204 Received unsupported character	An unsupported character was received
E210 Unknown command	Unknown command rights to small to read).
E214 Entered command is too long to be processed	The entered command with the parameters is too long (greater than 255 bytes).
E220 Timeout, command aborted	Timeout during mastering.
E232 Wrong parameter count	Too high or too small number of parameters.

E234 Wrong or unknown parameter type	A transmitted parameter has a wrong type or a wrong number of parameters were transmitted.
E236 Value is out of range or the format is invalid	The parameter value is out of range of the value range.
E262 Active signal transmission, please stop before	A measurement value transmission is active. Stop the data transmission in order to execute the command.
E320 Wrong info-data of the update	For update only: the header of update data contains an error.
E321 Update file is too large	For update only: update data is too large.
E322 Error during data transmission of the update	For update only: error during update data transmission.
E323 Timeout during the update	For update only: Timeout during the transmission of update data.
E331 Validation of import file failed	The import file is not valid.
Error message	Description
E332 Error during import	Error during processing the import data
E333 No overwrite during import allowed	No overwrite of measurement and device settings allowed through import, set the checkbox.
E350 The new passwords are not identical	Password and verification password do not match.
E360 Name already exists or not allowed	The measurement setting name already exists or is not allowed.
E361 Name begins or ends with spaces or is empty	Name for the measurement setting begins or ends with spaces or is empty.
E362 Storage region is full	Number of storable measurement settings is reached.
E363 Setting name not found	Name of the measurement setting to be loaded not found
E364 Setting is invalid	Measurement or device setting is invalid
E600 ROI begin is greater than ROI end	ROI begin is greater than ROI end.
E602 Master value is out of range	Master value is out of valid range

E616 Software triggering is not active	Software triggering is not active.
--	------------------------------------

Warning	Description
W320 The measuring output has been adapted automatically.	The measuring output has been adapted automatically.
W570 The input has been adapted automatically to a limited range.	---

A 4 Control Menu

A 4.1 Tab Home

Measurement task	Presets	<i>Standard</i>	<i>Suitable for materials made of ceramics, metal or filled plastics</i>
		<i>Changing surface ¹</i>	<i>Suitable for e.g. PCB or hybrid materials</i>
		<i>Material with penetration ¹</i>	<i>Suitable for plastics (POM, Teflon), materials with strong penetration of the laser</i>
	Setups ²	<i>Setup 1 ... Setup 8</i>	<i>Setups contain user-specific measurement settings. Unlike the presets they can be changed anytime.</i>
Signal quality		<i>Static / balanced / dynamic / off</i>	<i>The signal quality affects averaging of measurement values.</i>

1) Available for the sensor models ILD1420-10/25/50.

2) Menu item is available if at least one setup has been saved.

A 4.2 Tab Settings

A 4.2.1 Inputs

Laser on/off	<i>On / Off</i>		<i>Laser on/off is only effective when pin 8 is connected to GND.</i>
Multifunctional input	<i>Zeroing (Mastering)</i>	<i>High / Low</i>	<i>Sets the function of the digital input. The trigger affects recording and output of a measurement value. Zeroing/Mastering sets the current measurement value to the entered master value. Teaching scales the analog output. HTL is defined as active input level.</i>
	<i>Trigger In</i>	<i>High / Low</i>	
	<i>Teaching</i>		
	<i>Inactive</i>		
Key function	<i>Zeroing (Mastering)</i>		<i>Sets the function of the sensor key. Inactive means keylock.</i>
	<i>Teaching</i>		
	<i>Inactive</i>		

A 4.2.2 Signal Processing

Measurement task	<i>Standard</i>	<i>Suitable for materials made of ceramics, metal or filled plastics</i>
	<i>Multi-surface ¹</i>	<i>Suitable for e.g. Printed circuit boards (PCB) or hybrid materials</i>
	<i>Light penetration ¹</i>	<i>Suitable for plastics (POM, Teflon), materials with strong penetration of the laser</i>
Measuring rates	<i>250 Hz / 500 Hz / 1 kHz / 2 kHz / 4 kHz / 8 kHz</i>	<i>For light and matt measuring objects a high measuring rate may be required. For dark or bright measuring objects a slower measuring rate may be required (e.g. black lacquered surface) to improve the measuring result.</i>

1) Available for the sensor models ILD1420-10/25/50.

Recording trigger / Output trigger	Level			Continuous measurement output takes place as long as the selected level is applied. Level selection, see 7.3 . Pulse duration must at least be one cycle time. The subsequent break must also be at least one cycle time.
	Edge	infinite		Edge selection. „0“ end trigger, „1 ... 16382“ values per trigger, „16383“ infinite trigger
		manual	Number	
	Software	infinite		
manual		Number	Value	
Inactive				No triggering

Evaluation range	Start of range	0 ... 99 %	Value	Set region of interest, i.e. only this range is used for measurement value recording. „Start“ value must be smaller than „end“ value.
	End of range	1 ... 100 %	Value	End of range (< 100 %) is set individually for the ILD1420-500 sensors.

Selection of peak	First peak / Highest peak / Last peak	<p>Defines which signal is used for the evaluation in the line signal.</p> <p>First peak: Nearest peak to sensor.</p> <p>Highest peak: standard, peak with the highest intensity.</p> <p>Last peak: widest peak to sensor.</p>	

Error handling	Error output, no measurement value		<i>The analog output supplies 3 mA instead of measurement value. The RS422 interface outputs an error value.</i>	
	Hold last value infinite		<i>Analog output and RS422 interface stop at the last valid value.</i>	
	Hold last value	1 ... 1024	Value	
Measurement value averaging	No averaging		<i>Measurement values are not averaged.</i>	
	Moving N values	2 / 4 / 8 ... 128	Value	<i>Indication of averaging mode. The averaging number N indicates the number of consecutive measurement values to be averaged in the sensor.</i>
	Recursive N values	2 ... 32768	Value	
	Median N values	3 / 5 / 7 / 9	Value	
Zeroing/ Mastering	Inactive		<i>Normal measurement value or Zeroing/Mastering is undone.</i>	
	Active	Value	<i>Indication e. g. of thickness of a master part. Value range 0 up to max. + 2 x measuring range</i>	
Reduction of data	Value		<i>Indicates the sensor which data is to be excluded from output, thus the data amount to be transmitted is reduced.</i>	
Reduction is valid for	RS422 / Analog		<i>Interfaces to be used for undersampling are to be selected via the checkbox.</i>	

A 4.2.3 Outputs

RS422	Baud rate	9.6 / 19.2 / 56.0 / 115.2 / 230.4 ... / 1000 kBps	<i>Transmission speed, binary data format</i>
	Output data	<i>Distance / Exposure time / Intensity / Sensor status / Measurement value counter / non-linearized center of gravity / Timestamp / Video raw signal</i>	<i>Date to be transmitted are to be activated via the checkbox.</i>

Analog output	<i>Standard scaling</i>		<i>Start of measuring range 4 mA, at end of measuring range 20 mA</i>	
	<i>Two point scaling</i>	<i>Start of range</i>	<i>Value</i>	
		<i>End of range</i>	<i>Value</i>	
Digital output	<i>Inactive</i>		<i>Regulates the switching performance of the digital output (Error), see 5.4.8. Analog range: digital output switches when the scaled analog range is exceeded. Measuring range: The digital output is switched when the peak is not (entirely) in evaluation range (ROI). Limit monitoring: digital output switches when the limit is exceeded.</i>	
	<i>Analog range Measuring range</i>	<i>NPN / PNP / PushPull / PushPullNeg</i>		
	<i>Limit monitoring</i>	<i>NPN / PNP / PushPull / PushPullNeg</i>		
		<i>Limit</i>		<i>Value</i>
		<i>Hysteresis</i>		<i>Value</i>
		<i>Minimum holding period</i>		<i>Value</i>
Data output	<i>Web interface / Analog / RS422</i>		<i>Decides on the used interface for measurement value output. A parallel physical measurement value output via RS422 and analog is not possible. If web interface was selected, no measurement values are output via RS422 or current output.</i>	

		LED Output	Web interface		RS422	Current output
			Parametrization	Measurement chart		
Selected output interface	Web interface	yellow	•	•		
	RS422	green	•		•	
	Analog	red	•	•		•

A 4.2.4 System Settings

Unit on website	<i>mm / inch</i>		Unit in measurement value display	
Keylock	<i>Automatically</i>	<i>Range 1 ... 60 [min]</i>	Value	The keylock starts after expiry of the defined time. Clicking the button <i>Refresh</i> extends the interval until keylock starts.
		<i>Refresh</i>		
	<i>Active</i>		The key <i>Select</i> does not respond to entries, independent of user level.	
	<i>Inactive</i>		The key <i>Select</i> is active, independent of user level.	
Load & Save	Measurement settings	<i>Create setup / Setup 1 / ... / Setup 8</i>	<i>Load</i>	Activates a saved measurement setting setup.
			<i>Save</i>	Saves changed measurement settings to an existing setup.
			<i>Favorite</i>	Selects a setup which is used after reboot of the sensor.
			<i>Delete</i>	Deletes a setup.
			<i>Search</i>	You load an existing setup from a PC or the like to the ILD 1420 with both buttons.
			<i>Import</i>	
			<i>Export</i>	Saves the setup on a connected PC or the like.
	Device settings	<i>Create setup</i>	<i>Load</i>	Activates the saved device settings.
			<i>Save</i>	Saves changed device settings.
			<i>Search</i>	You load the device settings from a PC or the like to the ILD 1420 with both buttons.
			<i>Import</i>	
			<i>Export</i>	Saves the device settings on a connected PC or the like.

Import & Export	Create file	<i>Measurement settings</i>		<i>The measurement setting setups, the file with device settings and the boot file can be combined in one parameter set and exchanged with a PC or the like.</i>
		<i>Boot setup</i>		
		<i>Device settings</i>		
	Search		<i>Button starts file manager to select a parameter set.</i>	
Check file	<i>Overwrite existing setups (with the same name)</i>		<i>Dialog prevents inadvertent overwriting of existing settings.</i>	
	<i>Apply settings of the imported boot setup</i>			
	<i>Transmit data</i>			
Access permission	Current access permission	<i>Value</i>		<i>Read only</i>
	Logout / Login			<i>Button starts change of access permission.</i>
	User level reboot	<i>Professional / User</i>		<i>Sets the user level the sensor starts with after re-boot. In this case MICRO-EPSILON recommends the selection user.</i>
	Change password	Old password	<i>Value</i>	<i>Case-sensitive rules are observed for all passwords. Numbers are allowed. Special characters are not allowed. Maximum length is limited to 31 characters.</i>
		New password	<i>Value</i>	
Repeat new password		<i>Value</i>		
Change password			<i>Button causes change of password.</i>	

Reset sensor	Measurement settings	<i>The settings for measuring rate, trigger, evaluation range, selection of peak, error handling, averaging, Zeroing/Mastering, reduction of data and setups are deleted. The 1st preset is loaded.</i>
	Device settings	<i>The settings baud rate, language, unit, keylock and echo mode are deleted and the default parameters are loaded.</i>
	Reset all	<i>By clicking the button the settings for the sensor, measurement settings, access permission, password and setups are deleted. The 1st preset is loaded.</i>
	Restart sensor	<i>By clicking the button the sensor is rebooted with the settings made in the favorite setup, see 7.6.4.</i>

 Selection required or checkbox

 *Value* Specification of a value required

i The settings will be effective, if you click on the button `Apply`. After the programming all settings must be permanently stored under a parameter set so that they are available again when the sensor is switched on the next time.



MICRO-EPSILON MESSTECHNIK GmbH & Co. KG
Koenigbacher Str. 15 · 94496 Ortenburg / Germany
Tel. +49 (0) 8542/168-0 · Fax +49 (0) 8542/168-90
info@micro-epsilon.com · www.micro-epsilon.com
Your local contact: www.micro-epsilon.com/contact/worldwide/

X9751351-B082094TSw
© MICRO-EPSILON MESSTECHNIK