



# More Precision

**Eltrotec** // Industrial Endoscopes





Endoscopes from Micro-Epsilon Eltrotec are highly developed optical devices which are specially designed for use in industrial environments. The extensive product range and more than 40 years of experience allow an almost limitless variety of testing tasks. Depending on the application, rigid, flexible or video endoscopes are used.

#### Rigid Endoscopes

For visual inspection of straight bores or cavities. The high-quality, specially calculated lens systems offer outstanding image reproduction and, with their excellent resolution and brightness, facilitate the inspection of the smallest details. In addition to careful workmanship, high-quality materials such as the stainless steel shaft and specially coated fibers for transporting the light ensure a long service life. Due to the large variety of devices with different diameters, viewing directions and opening angles, a multitude of applications can be realized. The MKF-D is unique due to its manually swiveling prism head with which the most diverse directions of view can be set as desired. The endoscopes are repair-friendly. By combining with light sources, cameras etc. from our extensive product range, a simple rigid endoscope can be transformed into a rigid video endoscope.

#### Flexible Endoscopes

Ideal for tight radii, curved components or places that are difficult to access. The flexible endoscopes from Micro-Epsilon Eltrotec are available in different versions.

On the one hand, endoscopes with highly flexible probes with manually controlled probe tip angulation. The angular position can be fixed with a locking brake. The probe is very robust and waterproof due to the protective sheathing made of stainless tungsten braiding.

On the other hand, the smallest flexible fiber-optic endoscopes from 0.5 mm. The quartz fibers are protected in a sliding vinyl tube. The endoscopes can be customized in focus, probe length and opening angle and are easy to repair. In all systems, the image and light transmission takes place via individual, specially arranged fibers. Each fiber transmits one pixel from the lens to the eyepiece. By combining with light sources, cameras etc. from our extensive product range, a flexible endoscope can be transformed into a rigid video endoscope.

#### Video Endoscopes

Ideal combination of highly flexible probes with the possibility to store images and videos directly or to evaluate the results directly worldwide via Wi-Fi Live Stream. With a modern modular system, an extensive selection of probes with different diameters and working lengths as well as camera and light technologies can be combined in the best possible way. The continuously manually adjustable probe tip deflection can be perfectly fixed in the desired position. The software has numerous functions and can be operated intuitively via the touch display. Accessories such as interchangeable lenses, the adjustment of the working distance, an extremely short probe head or the possibility of simultaneous 0° as well as 90° vision characterize the systems.

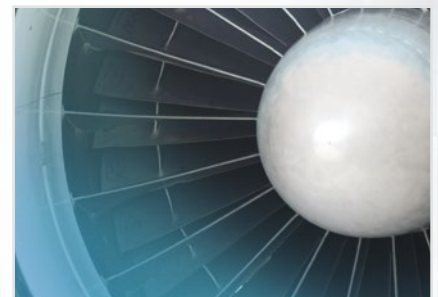
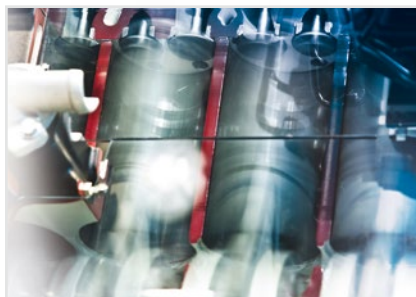
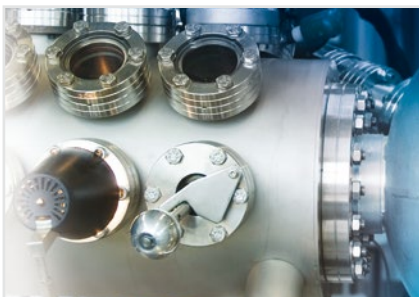

## Contents

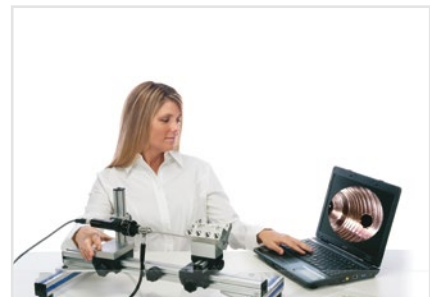
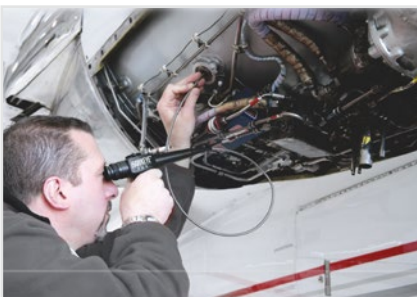

### Rigid Endoscopes - Eltrotec Borescopes

- Premium Endoscopes: SKF-D..... Page 4 - 5
- Endoscopes with Swing Prism: MKF-D..... Page 6 - 7
- 360° All-Round View in One Workflow: Panoramascope ..... Page 8 - 9
- Rigid Standard Endoscopes: Top-Line Pro ..... Page 10 - 11
- Flexible Miniature Endoscopes: ME ..... Page 12 - 13

### Flexible Endoscopes - ELTROTEC Flex

- Flexible Micro Endoscope: MTFS..... Page 14 - 15
- Top-Line Flexible Endoscopes: Flexible Pro..... Page 16 - 17

### Video Endoscopes - Eltrotec Video

- Fully Integrated Video Endoscope System: iRIS PRO ..... Page 18 - 21

### Accessories

- Light Sources ..... Page 22 - 23
- Fiber Optics / Adapter ..... Page 24
- Camera-Monitor System for Mobile Use ..... Page 25
- Cameras / Monitors ..... Page 26 - 27

### Technical Information

- Definition of Terms ..... Page 28 - 31



- Ø from 1 mm to 8 mm
- Perfect optical system
- Optimized light conductors for excellent image brightness
- External focus ring for diopter adjustment
- Rotatable probe

High quality lens systems provide clear and sharp images with perfect resolution. From the variety of different viewing directions and opening angles, you can choose the most suitable model of the SKF-D series for your

application. On models with lateral viewing direction the probe can be rotated. Thus the position of the internal part to be tested is irrelevant. Due to the offset focus ring and the possibility to unscrew the eye funnel, the

endoscopes are ideally suited for use with a camera. The object is illuminated by an external light source

Type SKF-D						
Outer-Ø mm	Direction of view	Aperture angle	Length mm	Rotatable probe	Article no.	90° Mirror tube
1.0	0°	50°	60	no	20812408	yes
			90	no	20812474	yes
1.7	0°	40°	110	no	20812476	yes
			153	no	20812478	yes
1.9	0°	70°	70	no	20082497	yes
			175	no	20082521	yes
2.8	0°	40°	125	no	20081160	yes
			254	no	20081161	yes
			383	no	20081162	yes
2.8	0°	90°	125	no	20081163	no
			250		20081164	
			380		20081165	
2.8	30°	80°	125	yes	20082498	no
			250		20082499	
			380		20082500	
2.8	70°	70°	125	yes	20082502	no
			250		20082503	
			380		20082504	
4.0	0°	40°	245	no	20081173	yes
			370		20081174	
4.0	0°	90°	125	no	20082505	no
			250		20082506	
			380		20082507	
			440		20082508	
4.0	30°	100°	125	yes	20082509	no
			250		20082510	
			380		20082511	
			440		20082512	

Type SKF-D						
Outer-Ø mm	Direction of view	Aperture angle	Length mm	Rotatable probe	Article no.	90° Mirror tube
4.0	70°	80°	125	yes	20082513	no
			250		20082514	
			380		20082515	
			440		20082516	
4.0	90°	55°	125	yes	20082517	no
			250		20082518	
5.8	0°	40°	135	no	20081187	yes
			275		20081188	
			415		20081189	
			555		20081190	
5.8	0°	100°	146	no	20081191	no
			286		20081192	
			426		20081193	
			566		20081194	
5.8	45°	65°	135	yes	20081195	no
			275		20081197	
			345		20081198	
5.8	70°	65°	135	yes	20081199	no
			205		20082000	
			275		20082001	
			345		20082002	
5.8	90°	65°	625	yes	20082519	no
			135		20082003	
			205		20082004	
8.0	0°	40°	275	no	20082005	yes
			225		20081135	
			425		20082007	
8.0	0°	100°	625	no	20082008	no
			236		20082010	
			436		20082011	
8.0	45°	55°	636	yes	20082012	no
			325		20082015	
			425		20082016	
8.0	70°	65°	625	yes	20082018	no
			225		20082019	
			425		20082021	
8.0	90°	65°	625	yes	20081612	no
			225		20082023	
			325		20082024	
			425		20082025	
			625		20082027	

#### Mirror tubes for standard endoscopes

- Deflection 90°
- Rotatable stainless steel tube - 360°
- Mirror in the form of a prism



Outer-Ø mm	Deflection	Article no. mirror tube	for Endoscope-Ø mm	for Length mm	Article no. endoscope
1.2	90°	20822409	1.0	60	20812408
		20822475		90	20812474
2.0	90°	20822477	1.7	110	20812476
		20822479		153	20812478
3.05	90°	20092055	2.8	125	20081160
		20092056		254	20081161
		20092057		383	20081162
4.5	90°	20092059	4.0	245	20081173
		20092060		370	20081174
6.3	90°	20092061	5.8	135	20081187
		20092062		275	20081188
		20092063		415	20081189
		20092064		555	20081190
8.5	90°	20092065	8.0	225	20081135
		20092066		425	20082007
		20092067		625	20082008



- Ø 6, 8 and 9 mm
- Continuously swiveling lens from -7° to 133°
- Perfect optical system
- Optimized light conductors for excellent image brightness
- External focus ring for diopter adjustment
- Probe rotatable by 370°

The Eltrotec MKF-D is unique thanks to its continuously swiveling lens from -7° to 133°. The entire region in front of the endoscope can be inspected by moving the prism. With the 370° rotatable probe no detail remains hidden.

High quality lens systems provide clear and sharp images with perfect resolution. Due to the offset focus ring and the possibility to unscrew the eye funnel, the endoscopes are ideally suited for use with a camera. The object is illuminated by an external light source.

#### Operating conditions:

- Temperature in air:
  - Endoscope probe: -20 °C to +100 °C
- Entire endoscope: -20 °C to +50 °C
- Pressure resistance in air: up to 2 bar
- Resistance to liquids:
  - The endoscope probe may be immersed in the following liquids for a short time: water, saline solution (5 %), kerosene, gasoline, diesel, 70 % alcohol
- Humidity: up to 95 % at 40° (non-condensing)

#### Application examples:



Oil filter

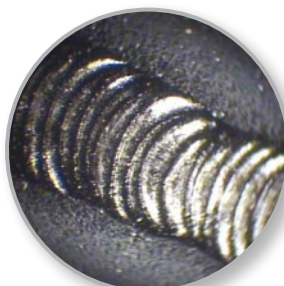

Inspecting a weld seam



Checking brake cylinder for burrs

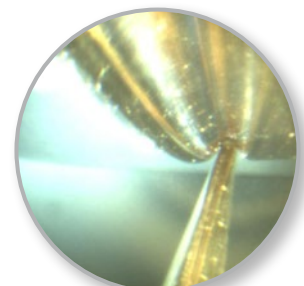

Slip ring

Type MKF-D					
Outer-Ø mm	Direction of view	Aperture angle	Length mm	Rotatable probe	Article no.
6	-7° to +133°	45°	175	yes	20122075
			315		20122077
			455		20122079
8	-7° to +133°	45°	185	yes	20122081
			325		20122083
			395		20122084
			465		20121369
9	-7° to +133°	45°	605	yes	20121370
			305		20122086
			405		20122087
			605		20122089
			805		20121510



Swing prism of the MKF-D

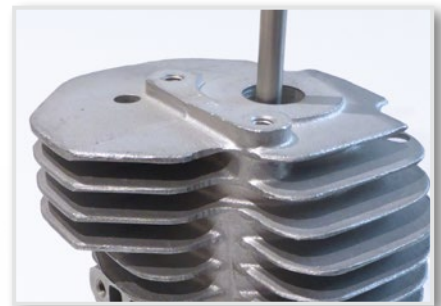
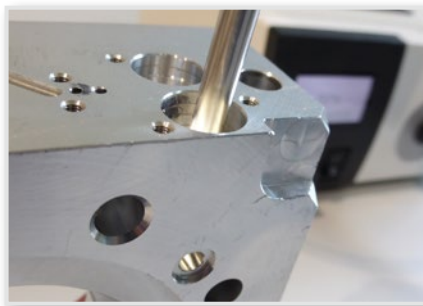
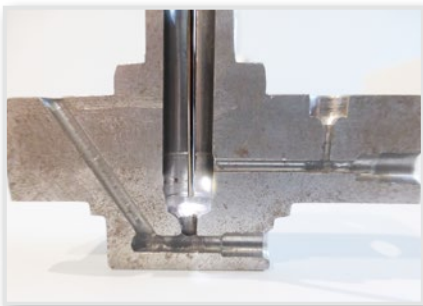
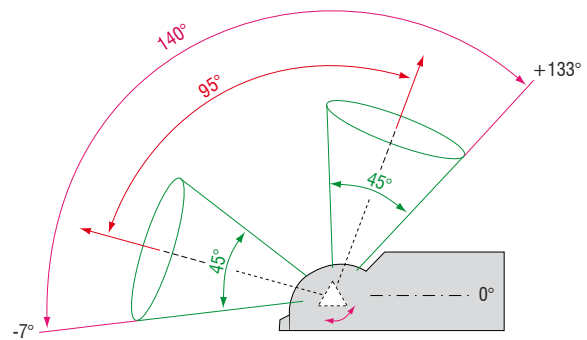

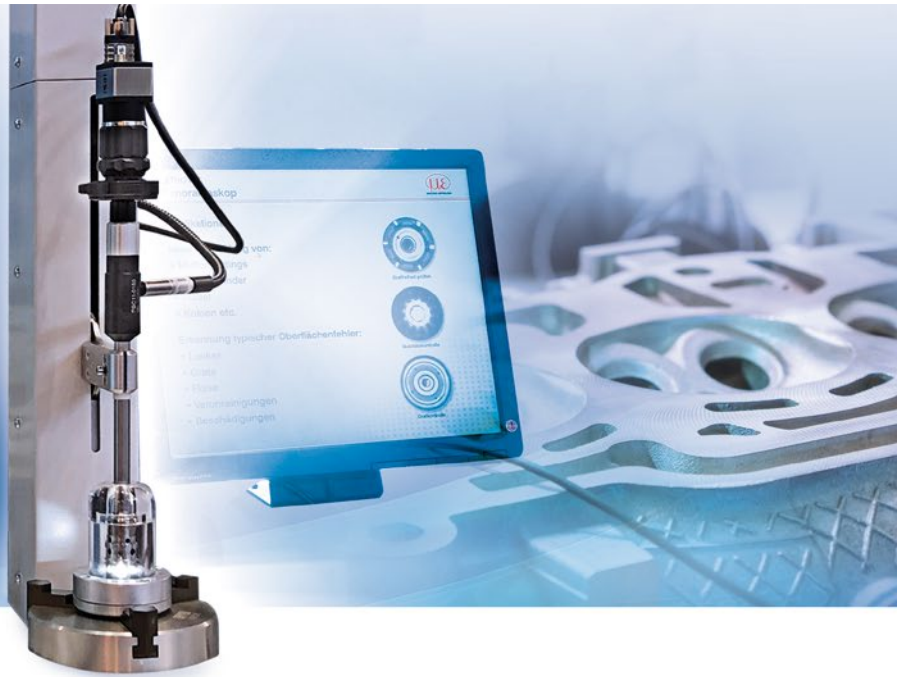

- Ø 6 mm and 11 mm
- Lengths: 80 mm to 400 mm
- Exchangeable panorama lens
- External focus ring
- Stainless steel design
- 360° all-round view

#### Time-saving inspection of hollow bodies due to 360° all-round view in one workflow

A special feature of the Micro-Epsilon Eltrotec Panoramascope is the drop-shaped 360° quartz glass lens. This lens records the surface image of a cylindrical bore and transfers this image to the eyepiece via an optical system.

A large number of illuminating fibers ensures optimal illumination, allowing for short exposure times when using image processing software.

The user can choose between different C-/CS-mount lenses.

#### Features:

- Outer diameter: 6 and 11 mm
- External focus ring
- Stainless steel design
- 360° all-round view
- Focal range: 2 mm to ∞
- Repair-friendly due to exchangeable panorama lens

#### Operating conditions:

- Temperature in air:
  - Endoscope probe:
    - Ø 11 mm: -20 to +100 °C
    - Ø 6 mm: -20 to +70 °C
  - Entire endoscope:
    - 20 °C to +50 °C
- The endoscope is splash-proof and the panorama lens is exchangeable

#### Applications

- Sleeves/fittings
- Brake cylinder
- Connecting rod
- Piston
- Punctures
- (Ball) bearing

#### Typical surface defects

- Blowholes
- Burrs
- Cracks
- Contamination
- Damage
- Porosity
- Coating
- Edge breakouts

#### Application examples:



Burr inspection



Quality control

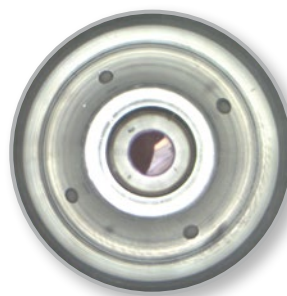

Checking for burrs



Casting defects



Model	Eltrotec Panoramascope	
Outer-Ø	6 mm	11 mm
Length	80 / 130 / 180 / 230 / 280 mm ±10 mm	160 / 240 / 320 / 400 mm ±10 mm
Image resolution	depending on camera > 0.05mm	
Aperture angle	approx. 90°	
Direction of view	approx. 90°	
Focal range	2 mm to ∞	
Impermeability	Endoscope is splash-proof and the panorama lens is exchangeable	
Illumination	Fiber optic connector for external light source	
Temperature resistance	-20 °C to +70 °C	-20 °C to +100 °C

Outer-Ø mm	Length mm	Article no.
6	80	20062322
	130	20062315
	180	20062317
	230	20062314
	280	20062316

Outer-Ø mm	Length mm	Article no.
11	160	20062305
	240	20062289
	320	20062306
	400	20062307

Accessories	Article no.
EL 1/3 1800 MEP/S fiber optics	20712529
Panorama lens with reflector	20062530
Panorama lens without reflector	20062334

Accessories	Article no.
EL 1/6 1800 MEP/S fiber optics	20712291
Panorama lens with reflector	20062531
Panorama lens without reflector	20062235

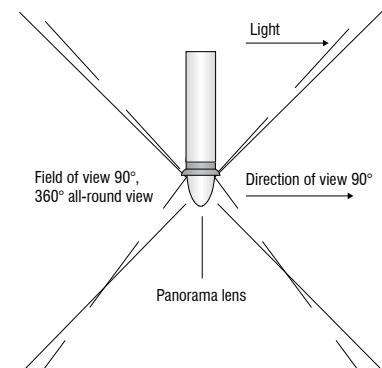
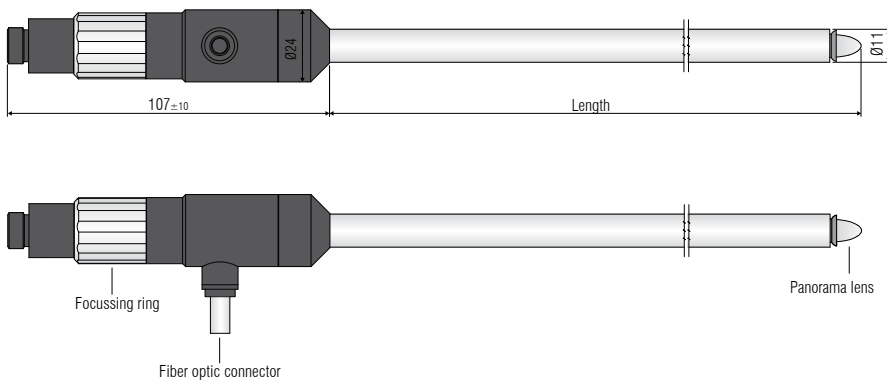

Accessories	Article no.
Eltrotec Endolight FOT LED 3000 light source	20912166
TV lens zoom with quick release (f: 18 - 35 mm), C-mount	20962209
TV lens with fixed focal length (f: 35 mm), C-mount	20962501
TV lens with fixed focal length (f: 28 mm), C-mount	20962502



Eltrotec Endolight FOT LED



Fiber optics



Lens



- Ø 1.85 mm to 7.2 mm
- Lengths: 80 mm to 940 mm
- Focal range from 2 mm to  $\infty$
- Optimized fiber-optic connector and external focus ring for adjusting of diopter
- Optionally with temperature resistance up to +300 °C

Top-line Pro endoscopes are highly sophisticated endoscopy devices.

A stepped focus ring and an optimized fiber-optic connection ensure the best possible light output. This makes the endoscopes ideally suited for use with a camera.

Mirror tubes and robust metal cases are available as accessories. The object is illuminated by an external light source.

The Top-Line Pro endoscopes are optionally available with a temperature resistance of up to +300 °C.

#### Operating conditions:

- Temperature in air:  
Endoscope probe: -20 °C to +120 °C  
Complete endoscope: -20 °C to +50 °C
- Pressure resistance in air: up to 5 bar
- Resistance to liquids:  
The endoscope probe may be immersed in the following liquids for a short time: water, saline solution (5 %), kerosene, gasoline, diesel, 70 % alcohol
- Humidity: up to 95 % at 40° (non-condensing)

#### Application examples:

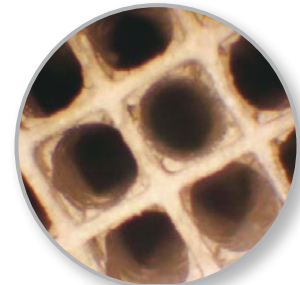

Catalytic converter inspection



Bearing inspection



Fiber optic connector

### Top-Line Pro Endoscope

Type Top-Line Pro	Outer-Ø mm	Direction of view	Aperture angle	Length mm	Article no.
ProMicroslim	1.85	0°	40°	80	20752184
				120	20752221
				178	20752222
ProSuperslim	2.4	0°	42°	102	20751409
				185	20751481
	2.8	0°	42°	265	20752224
				350	20752225
				435	20752226
ProSlim	4.2	0°	42°	50	20752205
				180	20752195
				305	20752202
				435	20752230
				560	20752215
ProHardy	6.35	0°	50°	180	20752231
				305	20752232
				435	20752233
				560	20752234
ProSuperHardy	7.2	0°	50°	711	20752194
				940	20752191

### Mirror tubes for Eltrotec Pro Endoscopes

- Direction of view 90°
- Rotatable stainless steel tube - 360°
- Mirror in the form of a prism



Outer-Ø mm	Direction of view	Article no. mirror tube	for Endoscope-Ø mm	Length mm	Article no. endoscope
2.2	90°	20751389	1.85	80	20752184
		20752096		120	20752221
		20752223		178	20752222
2.77	90°	20751392	2.4	102	20751409
		20751393		185	20751481
		20752227		265	20752224
3.8	90°	20752228	2.8	350	20752225
		20752229		435	20752226
		20752236		50	20752205
4.8	90°	20750838	4.2	180	20752195
		20751091		305	20752202
		20751397		435	20752230
		20751765		560	20752215
		20751401		180	20752231
8.0	90°	20751402	6.35	305	20752232
		20751143		435	20752233
		20752235		560	20752234
8.0	90°	20752193	7.2	711	20752194
		20752192		940	20752191



- Ø 0.9 mm to 2.0 mm
- Lengths: 20 mm to 450 mm
- High quality quartz fibers
- Focusable from 1 mm to ∞
- Easily pliable - high break resistance provides robustness
- External focus ring for diopter adjustment

The miniature Eltrotec ME endoscope is ideally suited for the inspection of miniature components and channels in the field of microelectronics and precision engineering.

High-quality quartz fibers are used for image transmission, so the ME can be bent easily without damage. This ensures a long service life especially for smallest diameters in long lengths. The image quality is comparable to that of all conventional lens systems. The protruding knurls present another advantage. One is used to adjust the focus and the other to adjust the focus. A special adaptation to your component is possible.

Objects are illuminated by an external light source from the accessory range. The endoscopes can optionally be connected to a camera system.

#### Operating conditions:

- Temperature in air:
  - Endoscope probe: -20 °C to +60 °C
  - Complete endoscope: -20 °C to +50 °C
- Pressure resistance in air: up to 5 bar
- Resistance to liquids:
  - The endoscope probe may be immersed in the following liquids for a short time: water, saline solution (5 %), kerosene, gasoline, diesel, 70 % alcohol
- Humidity: up to 95 % at 40° (non-condensing)

#### Application examples:



Deposits in pipe

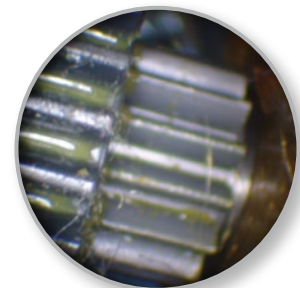

Gear wheel

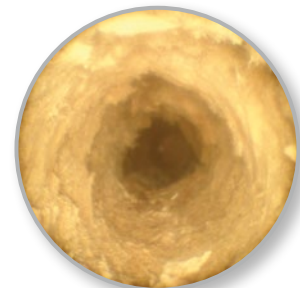

Deposits in pipe

Type ME					
Outer-Ø mm	Direction of view	Aperture angle	Resolution	Length mm	Article no.
0.9 - 1.3	0°	50°	10,000	20	20531943
				60	20531944
				100	20531945
				140	20531946
				180	20531947
1.4 - 2.0	0°	70°	10,000	20	20531948
				60	20531949
				100	20531950
				140	20531951
				180	20531952
				220	20531953
				260	20531954
				300	20531955
1.4 - 2.0	0°	60°	30,000	350	20531956
				400	20531957
				450	20531958
				20	20530958
				60	20531959
				100	20531960
				140	20531961
				180	20530308
				220	20531962
				260	20531963
1.5 - 2.0	90°	70°	10,000	300	20531964
				350	20531965
				400	20531966
				450	20531967
				20	20531968
				60	20531969
				100	20531970
				140	20531971
				180	20530372
				220	20531973
260	20531974				
300	20531975				
350	20531976				
400	20531977				
450	20531978				

All endoscopes available with outer-Ø in increments of 0.1mm

Accessories		
Article		Article no.
Fiber optics	Length: 1500 mm, in PVC tube with FOT connection	20541980
90° mirror tube, up to ø 1.3 mm	rotatable, outer-ø = endoscope + 0.2 mm	20541979
90° mirror tube, from ø 1.4 mm	rotatable, outer-ø = endoscope + 0.3 mm	20540309



- Ø 0.5 mm to 2.5 mm
- Lengths: 500 mm to 15,000 mm
- Aperture angle up to 100°
- High quality quartz fibers
- Pliable - high break resistance provides robustness
- External focus ring for diopter adjustment
- Custom adaption possible

Eltrotec Flex MTFS fiber-optical endoscopes are extremely small, flexible and serve as valuable tools and inspection devices in many areas of quality assurance. Despite their extremely small outer diameter, the flexible micro endoscopes are high-quality instruments with good image sharpness, true color reproduction and a resolution of up to 30,000 pixels, suitable for the inspection of miniature components and channels in microelectronics, precision engineering and research.

Objects are illuminated by an external light source from our accessory range. The endoscopes can optionally be connected to a camera system.

#### Operating conditions:

- Temperature in air:
  - Endoscope probe: -20 °C to +60 °C
  - Complete endoscope: -20 °C to +50 °C
- Pressure resistance in air: up to 5 bar
- Resistance to liquids:
  - The endoscope probe may be immersed in the following liquids for a short time: water, saline solution (5 %), kerosene, gasoline, diesel, 70 % alcohol
- Humidity: up to 95 % at 40° (non-condensing)

#### Application examples:

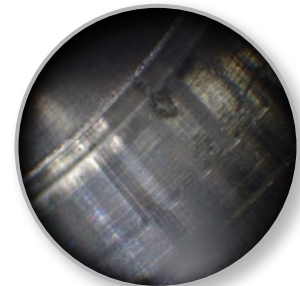

Chatter marks

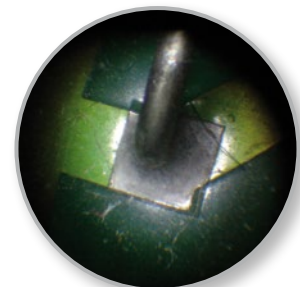

Inspecting soldered joints

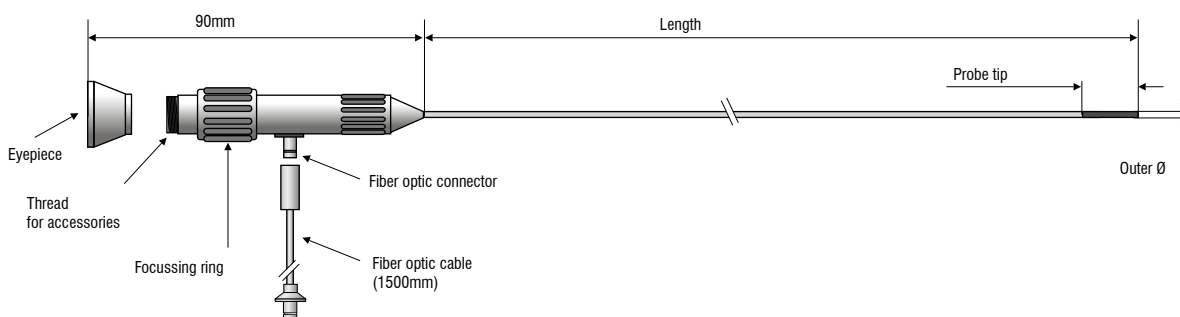

Model MTFs	050	075	100	150	200	250
Outer-Ø	0.5 mm	0.75 mm	1.0 mm	1.5 mm	2.0 mm	2.5 mm
Length	0.5 / 1.0 / 1.5 / 2.0 m				2/3/4/5 m	2/5/10/15 m
Resolution	4000 pixels	6000 pixels	10,000 pixels	30,000 pixels		
Direction of view	direct view 0°					
Aperture angle approx.	70°			60°	70°	
Focal range	3 to 50 mm				10 mm to ∞	
Diopter compensation	adjustable					
Min. bending radius	10 mm	15 mm	30 mm	50 mm	60 mm	80 mm
Rigid part max.	5 mm	5 mm	6 mm	7 mm	10 mm	12 mm
Illumination	separate or permanently connected fiber optics with a length of 1500 mm for external light source					
Camera and TV connection	eyepiece equipped for the attachment of a corresponding adapter					
Temperature resistance	up to 60 °C					

Outer-Ø mm	Length mm	Direction of view	Article no.
0.5	500	0°	20560930
0.5	1000	0°	20561733
0.5	1500	0°	20561734
0.5	2000	0°	20561880
0.75	500	0°	20561004
0.75	1000	0°	20560321
0.75	1500	0°	20561732
0.75	2000	0°	20560939
1.0	500	0°	20560854
1.0	1000	0°	20560322
1.0	1500	0°	20561731
1.0	2000	0°	20560895
1.5	500	0°	20561000
1.5	1000	0°	20561589
1.5	1500	0°	20561584
1.5	2000	0°	20560896
2.0	500	0°	20561985
2.0	1000	0°	20561986
2.0	1500	0°	20561987
2.0	2000	0°	20561988
2.0	3000	0°	20561989
2.0	4000	0°	20561990
2.0	5000	0°	20561827
2.5	500	0°	20560336
2.5	1000	0°	20561983
2.5	1500	0°	20561984
2.5	2000	0°	20561689
2.5	5000	0°	20561826
2.5	10,000	0°	20561981
2.5	15,000	0°	20561982

Endoscopes with external Ø up to 2.0 mm with permanently connected fiber optics

Accessories:	Article no.
Fiber optic cable for MTFs (1500 mm, Ø 2 mm fiber cross section)	20560670
Mirror head, d=1.4 mm, direction of view 90°	20560897
Mirror head, d=1.9 mm, direction of view 90°	20560898
Mirror head, d=2.4 mm, direction of view 90°	20561413



- Ø 2.5 mm to 5 mm
- Lengths: 700 mm to 1200 mm
- Resolution up to 18,000 pixels
- Probe tips can be angled on 2 sides
- Complete set in a handy case
- External focus ring for diopter adjustment

Flexible Top-Line endoscopes are ideal for narrow radii, curved components or hard-to-reach places, as the probe is very flexible. The probe tip deflection is controlled manually. The angular position can be fixed with a parking brake. The probe is very robust with the protective sheathing made of stainless tungsten braiding.

A mirror or prism head is optionally available from a diameter of 3.3 mm. The endoscopes can be operated independently of the mains with a hand lamp or with an external light source. The connection to a camera system is possible.

#### Operating conditions:

- Temperature in air:
  - Endoscope probe: -20 °C to +60 °C
  - Complete endoscope: -20 °C to +50 °C
- Pressure resistance in air: up to 5 bar
- Resistance to liquids:
  - The endoscope probe may be immersed in the following liquids for a short time: water, saline solution (5 %), kerosene, gasoline, diesel, 70 % alcohol
- Humidity: up to 95 % at 40° (non-condensing)

#### Complete set:

- Top-Line flexible endoscope
- 90° mirror head (with Flexible Pro ø 5 mm, optional 90° prism head)
- SuperNova LED
- Robust aluminum case
- Li-Ion battery with charging device

#### Application examples:



Position of a screw

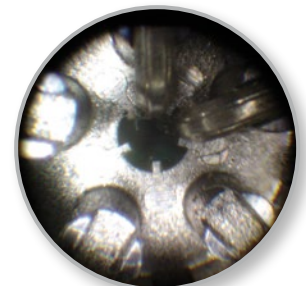

Position check





Top-Line	Flexible Pro				
Outer-Ø	2.5 mm	2.5 mm	3.3 mm	4 mm	5 mm*
Length	700 mm	1200 mm	850 mm		
Resolution	7,000 pixels		18,000 pixels		
Direction of view	0° / 90°		0°		
Aperture angle	60°		45°		
Focal range	5 mm to ∞				
Mirror head	-				90° mirror head
Probe tip angle (articulation)	2 times, 120° each				
Bending radius	35 mm	35 mm	40 mm		
Temperature resistance	≤ 60°				
Part number	20751770	20751771	20751886	20751893	20751639

\*90° prism head available

Accessories	Article no.
90° mirror head for Flexible Pro, only with ø 5 mm	20751641
90° prism head for Flexible Pro, only with ø 5mm	20751678



90° mirror head



90° prism head (optional)



SuperNova LED hand light source



Information about other flexible endoscopes with numerous different diameters can be received on request.

Please contact us - we will advise you on the selection of the optimal solution tailored to your needs.



- Ø 2.4 mm to 8 mm
- Short probe head
- Compact video endoscope system as modular system
- Resolution up to 18,000 pixels
- Wi-Fi Live Stream
- 0° and 90° view at a glance

The compact video endoscope systems from Micro-Epsilon Eltrotec present the optimum solution for your mobile application.

The modular system has a wide range of probes with different diameters and working lengths as well as camera and light technologies. This results in a huge spectrum of configuration possibilities.

The perfect solution for your application is always possible!

The PRO SERIES allows infinite variations. Choose a compact device for your specific application. Or put together the right system for different areas of application and expand it as required.

**DUAL VIEW**

0° and 90° view simultaneously from 4 mm diameter

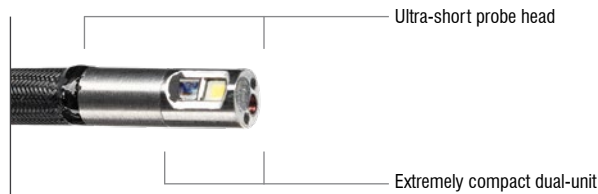

**DUAL SCOPE**

**0° Visibility and 90°-view at the same time**

The laterally installed 90° camera is located directly at the distal end. This directly enables dual vision without delay. The distal end is extremely short due to the compact design and thus provides the best possible navigation characteristics.

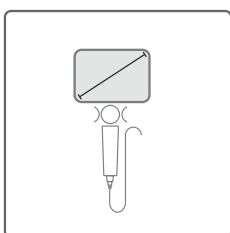

7" touch display

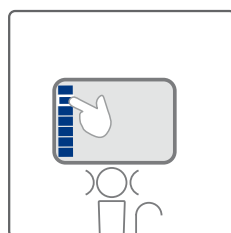

EIOS software



Wi-Fi Live Stream

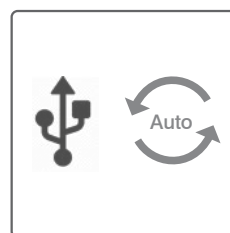

USB Auto synchronization

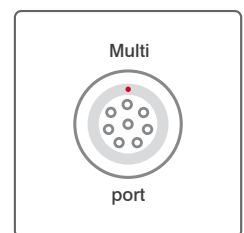

USB Analog Video OUT

The most important technical features of video endoscope systems at a glance.  
Please contact us - we will advise you on the selection of the optimal system.

## Monitor

Model	Monitor for iRIS X PRO / iRIS X PRO / iCAPTURE PRO	
Display size (diagonal)	7.0"	
Display type	TFT/color display with touchscreen	
Resolution	1024 x 600 pixels	
User interface	EIOS Endoscopic Imaging Operation System	
Menu operation	on-screen menu	
Settings	Camera control, inversion, zoom, full-screen mode (switchable), storage location, file manager, resolution, logo, Auto timeout, date, time	
Text comments	integrated text-overlay generator	
Languages	German, English, French, Spanish, Italian, Russian, Chinese	
Interfaces	USB, data can be forwarded "wireless"; 8-PIN interface for probe connection; power supply: 12 V power supply unit	
Power supply	primary	replaceable Li-Ion battery included
	secondary	12 V power supply unit
	Video format	MPEG4 (.avi) (with time and date stamp)
Documentation	Image format	BMP (.bmp), JPEG (.jpg), PNG (.png) (with time and date stamp)
	Storage	internal memory 16 GB/USB (16 GB included)
Image analysis	Method	comparative, optical measurement
	Model	high power LED with fiber optics or LED on the TIP approx. 6500 k
Illumination	Light setting	three-stage
	Service life	approx. 5000 h
Ergonomics		$\pm 90^\circ$ rotatable display or $\pm 90^\circ$ rotatable stand
	Dimensions (H x W)	187 mm x 129 mm, diagonal 104 mm
	Weight	1.28 kg
Other data	Housing	robust PU with full rubber protection
	Operating temperature (system)	-25 °C to +46 °C
	Storage temperature	-25 °C to +60 °C
	Humidity	max. 95% - non-condensing
	Protection class	IP54

## Probes - permanently connected to the monitor or separately combinable in different diameters

Diameter mm	2.4; 3; 4; 6; 8
Length m	$\varnothing$ 2.4 mm 1.0 to 2.0; $\varnothing$ 3.0 mm 1.0 to 2.0; $\varnothing$ 4.0 mm 1.5 to 4.0; $\varnothing$ 6 + 8 mm 1.5 to 10.0
Angular deflection by means of tactile control	$\varnothing$ 2.4 + 3.0 mm 2-fold; from $\varnothing$ 4.0 mm 2-fold and 4-fold
Camera sensor	high resolution Super HAD / CCD image sensor or AIT Advance Image Sensor
Probe	robust braided tungsten
Direction of view	0° / 90° selectable
Aperture angle	90°
Dual probe	from $\varnothing$ 4.0 mm
Side view adapter	from $\varnothing$ 4.0 mm depending on the version
Interchangeable lenses	from $\varnothing$ 6.0 mm depending on the version
Weight	approx. 300 g depending on length and diameter
Operating temperature (probe):	140 °C max. 5 minutes -25 °C to +80 °C
Storage temperature	-25 °C to +60 °C
Humidity	max. 95 % - non-condensing
Water tightness	up to 1 bar - 10.2 m H <sub>2</sub> O
Resistance	Probe can be immersed for a short time in salt solutions (5%), kerosene, petrol, diesel, alcohol (50%)
Protection class	IP67

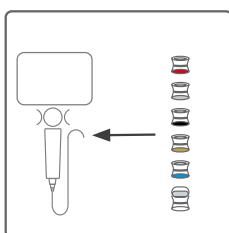

Interchangeable lenses

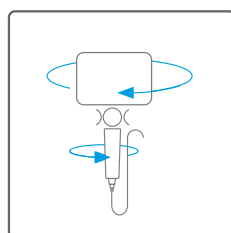

360° swivel monitor

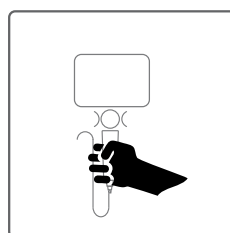

Compact

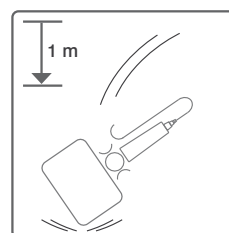

Shock-proof



Splash-proof

## Configure your System:

### COMPACT

#### iRIS X PRO/ iRIS 7 PRO Video endoscopic system

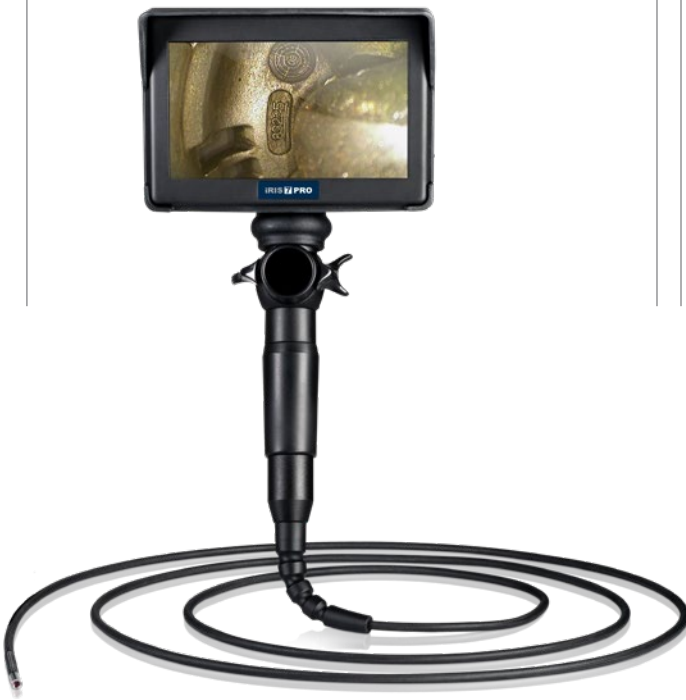

- 2-fold/ 4-fold angulation
- 2.4 | 3.0 | 4.0 | 6.0 | 8.0 mm probe diameter
- Digital sensor / full-frame sensor
- Interchangeable lenses
- DUAL PROBE option

#### iCAPTURE PRO Documentation unit



The iCAPTURE PRO can be combined and connected with all PRO video probes as well as all rigid and fiber-optic Eltrotec endoscopes in conjunction with the CUBECAM PRO. Alternatively, the endoscopes can be used with the HDMI PRO Box or the HDMI ZOOM Box with a separate monitor.

## Interchangeable Probes

- 2-fold / 4-fold angulation
- 2.4 mm/ 3.0 mm / 4.0 mm/ 6.0 mm/ 8.0 mm probe diameter
- Digital sensor / Full-frame sensor
- DUAL PROBE option/ interchangeable lenses

#### Probe diameter



#### Working lengths



## MODULAR

**XLED PRO**  
Videoscope



**iLED PRO**  
Videoscope



**XLED 3**  
Videoscope



### Interchangeable Lenses

For different conditions (6 and 8 mm probe diameter)



### SMART-FOCUS Close and Far Focus by Turning the Lens

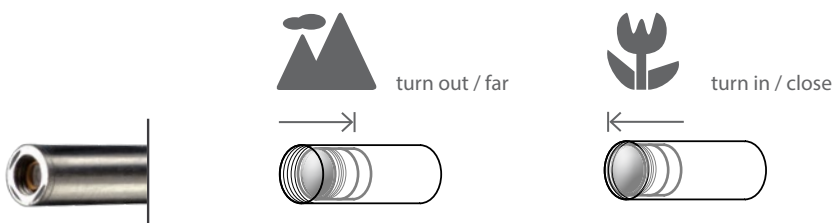

## High Performance LED Light Source Eltrotec Endolight FOT LED

- Robust, long-life and energy-efficient light source
- Quiet fan
- Brightness is continuously adjustable, selected setting is retained after a restart
- Automatic LED switch-off when fiber optics is removed
- Different filters available
- Electronic shutter feature
- Easily configurable settings (brightness, shutter/strobe parameters)
- Control via USB and foot switch

Model	ELTROTEC Endolight FOT LED 3000	ELTROTEC Endolight FOT LED 5100
Part number	20912166	20912342
Light source	high-power LED (white)	
Light power	max. 65 W	max. 100 W
Brightness	approx. 640 lm with fiber Ø 8x1000 mm	approx. 1200 lm with fiber Ø 8x1000 mm
Color temperature	5,800 K ± 5 %	6,500 K ± 5 %
Service life	up to max. 30,000 h*	
Brightness control	continuously up to 0 - 100 %	
Cooling	axial fan	
Display	LCD graphics display for operating display and menu functions	
Fiber optics adapter Ø	15 mm	
Interface	USB port for control from PC; ESD/DC socket, mono jack 2.5 mm for foot switch	
Dimensions (W x D x H)	170 x 205 x 98 mm	
Housing	robust metal housing; vertical positioning is possible, stackable	
Weight	approx. 3800 g (without power supply unit)	
Power supply	100 - 240 V / 50/60 Hz	
Power supply	12 VDC, 5420 mA	12 VDC, 4100 mA
Operating temperature	10 °C to 40 °C, max. 80% relative humidity, max. 2000 m (MASL)	
Storage temperature	-25 °C up to 70 °C, max. 80% relative humidity (non-condensing)	
Protection class	2	
Conformity	CE (EMC Directive 2004/108/EC), RoHS	

\*70% of the output brightness



FOT LED 3000 / 5100

## ELTROTEC Endolight FOT LED without Fan

- Continuous brightness adjustment
- No fan (no vibrations, stability)
- Suitable for heavily polluted air (no air turbulences), low noise requirements and applications requiring absence of vibrations
- ESD socket for external accessories

Model	ELTROTEC Endolight FOT LED without fan
Part number	20912161
Light source	high-power LED (white)
Light power	22 W
Brightness	approx. 335 lm
Color temperature	5,500 K
Service life	up to max. 50,000 h*
Brightness control	continuously variable due to rotary potentiometer
Cooling	fan-less due to convection
Control display	LED
Fiber optics adapter Ø	15 mm
Interface	none
Dimensions (W x D x H)	110 x 180 x 96 mm
Housing	robust metal housing
Weight	approx. 2500 g without power supply unit
Power supply	100 - 240 V / 50/60 Hz
Power supply	24 VDC ± 5 %, 1000 mA
Operating temperature	10 °C to 40 °C, max. 80% relative humidity, max. 2000 m (MASL)
Storage temperature	-25 °C to 70 °C, max. 80% relative humidity (non-condensing)
Protection class	3
Conformity	CE (EMC Directive 89/336/EEC), RoHS

\*depending on the ambient temperature, room humidity and the intensity set



FOT LED without fan

## Hand Light Sources

- Network-independent operation for mobile applications
- Easily screwed onto the endoscope with ACMI-/Wolf connector

Model	ELTROTEC LED Hand light source	ELTROTEC SuperNova LED Hand light source
Part number	20751761	20752271
Light source	LED (white)	LED (white)
Brightness	approx. 225 lm	approx. 320 lm
Color temperature	5000 K	5200 K
Service life	up to max. 50,000 h*	up to max. 50,000 h*
Brightness control	continuously adjustable with mechanical aperture	continuously adjustable with mechanical aperture
Dimensions	165 x 25 mm (L x Ø)	150 x 34 mm (L x Ø)
Housing	robust metal housing with ribbed handle	
Weight	approx. 117 g with batteries	approx. 148 g with Li-ion battery
Battery life time	approx. 6 hours (AA batteries)	approx. 2.5 hours
Battery charging time	-	approx. 3.5 hours
Battery charger	-	90 - 250 VAC / 50 - 60 Hz
Supply voltage	-	90 - 250 VAC / 50 - 60 Hz
Operating temperature	10 °C to 40 °C, max. 80% relative humidity, max. 2000 m (MASL)	
Storage temperature	-15 °C to 60 °C, max. 80 % relative humidity (non-condensing)	
Protection class	IPX4	IPX4
Replacement charging station	-	20752285
Spare accumulator	-	20752286

\*depending on the light intensity set



LED hand-held light source



SuperNova LED hand light source

## Fiber Optics for Light Sources

### Type EL 1/4 1800 MEP/S

- Glass fibers with a high packing fraction
- Total fiber bundle 4 mm /1800 mm long
- Metal protective tube with PVC coating

### Liquid fiber optic cable type FL 1/4 1800

- Greater bending radii than glass fiber lighting cables
- Lighting bundle Ø 4 mm
- Metal protective tube with PVC coating



Fiber optic cable EL

Article	Article no.
Fiber optics EL 1/4 1800 MEP with Lemo 1 adapter	20710831
Fiber optics EL 1/4 1800 MEP/S with universal adapter	20711767
Liquid light conductor FL 1/4 1800 MEP with Lemo 1 adapter	20710446
Liquid light conductor FL 1/4 1800 MEP/S incl. universal adapter	20711803
Adapter Lemo 1 to fiber optics	21061030
Adapter Lemo 2 to fiber optics	21061063

## Camera Adapter

C-mount TV lens with quick release	Article no.
ELTROTEC TV lens Vario-Zoom f: 15 - 35 mm	20962401
ELTROTEC TV lens Fzoom f: 25 - 40 mm	20961001
ELTROTEC TV lens Focus/zoom f: 18 - 35 mm	20962209
ELTROTEC TV lens f: 14 mm HD	20962397
ELTROTEC lens VC 20	20751998
ELTROTEC lens VC 25	20751488
ELTROTEC lens VC 35	20751225

C-mount TV lens with screw-threaded lens	Article no.
ELTROTEC TV lens type f: 40 mm	20962437
ELTROTEC TV lens type f: 28 mm	20962471
ELTROTEC TV-lens f: 35 mm, M14x1	20962501
ELTROTEC TV lens type f: 28 mm, M14x1	20962502

Angled eyepiece / 90° AE9003	Article no.
Attachable to all endoscope eyepieces of the Top-Line series with Ø 32 mm eyepiece	20751227



## Fiber-Optic Lighting Units

### Eltrotec Components for Visual Inspections

Fiber optic lighting units are used to facilitate the static illumination of objects. A range of attachments enables inaccessible objects to be accessed and illuminated. Light source, fiber optic cable and attachment produce an effective lighting unit.

Fiber optic cable*	Article no.
Fiber optic cable, UL1 - 1200	20710424
Fiber optic cable, UL1 - 1800	20710425

\*in metal tube with PVC coating, outer Ø 8 mm, bundle Ø 4 mm, FOT adapter

Rigid probe*	Article no.
Straight model, UST/A	21060435
Slightly angled, UST/C	21060436
Angled at 90°, UST/B, r=10 mm	21060547

\* attachable to UL fiber optics, length 150 mm, outer Ø 3 mm, bundle Ø 2 mm for the illumination of drill holes, specially for tool making





## ELTROTEC Analog Color Camera - CUBECAM PRO

- Upgrading rigid and flexible endoscopes to video endoscopes
- Use only with the ELTROTEC iCapture Monitor

Model	CUBECAM PRO
Part number	27.900.17.PRO
Image sensor	1/3" CCD
Resolution	752 x 582 pixels
Horizontal resolution	>428 lines
Color	Bayer pattern
Shutter speed	auto (1/50 s to 1/10,000 s)
Images per second	50
White balance	automatic
Lens connection	C-Mount
Interface	Video output 8-pin
Power supply	12 VDC (via iCapture Monitor)
Dimensions (L x W x D)	47mm x 47mm x 55mm
Weight	85 g
Operating temperature	0 °C to +50 °C
Storage temperature	-20 °C to +60 °C
Connection cables	L 1800 mm



## Documentation Unit

### ELTROTEC iCapture PRO Monitor

- Upgrading rigid and flexible endoscopes to video endoscopes
- Use only with analog "CUBECAM PRO" color CCD cameras

Model	Monitor for iRIS X PRO / iRIS X PRO / iCAPTURE PRO
Part number	27.900.31.PRO
Display size (diagonal)	7.0"
Display type	TFT/color display with touchscreen
Resolution	1024 x 600 pixels
User interface	EIOS Endoscopic Imaging Operation System
Menu operation	on-screen menu
Settings	Camera control, inversion, zoom, full-screen mode (switchable), storage location, file manager, resolution, logo, Auto timeout, date, time
Text comments	integrated text-overlay generator
Languages	German, English, French, Spanish, Italian, Russian, Chinese
Interfaces	USB, data can be forwarded "wireless"; 8-PIN interface for probe connection;
Power supply	primary: 12 V power supply unit secondary: replaceable Li-Ion battery included
Documentation	Video format: MPEG4 (.avi) (with time and date stamp) Image format: BMP (.bmp), JPEG (.jpg), PNG (.png) (with time and date stamp) Storage: internal memory 16 GB/USB (16 GB included)
Image analysis	Method: comparative, optical measurement
Other data	Ergonomics: ± 90° rotatable display or ± 90° rotatable stand Dimensions (H x W): 187 mm x 129 mm, diagonal 104 mm Weight: 1.28 kg Housing: robust PU with full rubber protection Operating temperature (system): -25 °C to +46 °C Storage temperature: -25 °C to +60 °C Humidity: max. 95% - non-condensing Protection class: IP54



## ELTROTEC Full HD-HDMI Color Cameras

- For all rigid and flexible Eltrotec endoscopes
- Easy image transmission to analog monitor (TV set)
- No PC / software required
- 2 crosshairs can be displayed
- 8 DSP profiles freely configurable

Model	Endo CA1/3
Image sensor	1/2,8" CMOS
Resolution	1920 x 1080 pixels
Pixel size	2.8 $\mu\text{m}$
Color	yes
Images per second	25/50 or 30/60 switchable
White balance	auto / reset
Lens connection	C-Mount
Interface	HDMI
Power supply	12 VDC
Dimensions	40 x 40 x 45.8 mm
Weight	120 g
Part number	20962599

Accessories	Part number
HDMI connection cable 3 m	20972624
Remote control	20972609
Power supply unit	20972608

## Monitors

- Visualization of results
- Robust industrial monitors
- High color brilliance

Model	Monitor 17"
Resolution (pixels)	1280x1024
Display element	Color TFT/LCD
Viewing angle	horizontal 160°, vertical 160°
Screen diagonal	17", 43 cm
Typ. brightness	250 cd/m <sup>2</sup>
Contrast ratio	1000:1
PC inputs	VGA
Typ. reaction time	5 ms
Video input	Y/C, VGA, HDMI, Composite (FBAS)
Power supply	12 VDC
Housing color	anthracite
Housing material	Aluminum
Weight	6 kg
Dimensions (incl. base)	416x398x49.5 mm
Certifications	CE
Part number	20961887



Identifying contamination



Burr inspection



## ELTROTEC USB Cameras

- For all rigid and flexible Eltrotec endoscopes
- Connection to notebook
- Network-independent operation for mobile applications
- Software included

Model	Endo CU1/2" 2,3 MP	Endo CU 1/1,8" 5 MP	Endo CU 1/1,8" 5 MP
Part number	20962603	20962662	20962676
Image sensor	1/2" CMOS	1/1,8" CMOS	
Resolution	1936 x 1216 pixels	2472 x 2064 pixels	4000 x 3000 pixels
Pixel size	2.35 $\mu\text{m}$	2.74 $\mu\text{m}$	1.85 $\mu\text{m}$
Color	yes		
Exposure time (min. - max.)	0,023 - 2000 ms	0,009 - 2000 ms	0,040 - 609 ms
Images per second	166	75	33
White balance	yes		
Lens connection	C-Mount		
Interface	USB 3.0		
Power supply	USB cable		
Dimensions	29 x 29 x 29 mm (L x W x D)		
Weight	49 g	50 g	48 g
Operating temperature	0 °C to 55 °C, max. 80% relative humidity		
Storage temperature	-20 °C to 60 °C, max. 80% relative humidity, non-condensing		
Protection class	IP30		
USB connection cables	20972300 / L: 3 m		
USB connection cable 3 m with angled connector	20972284		



Endo CU1/2" 2,3 MP



Endo CU 1/1,8" 5 MP



Endo CU 1/1,8" 12 MP

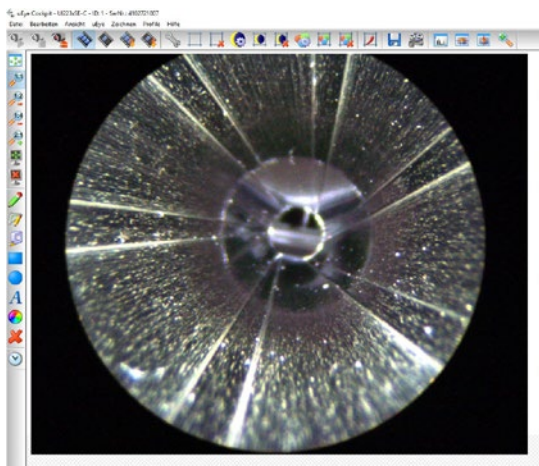

Software 20961601 + 10962299



## 1 Components of Rigid Endoscopes

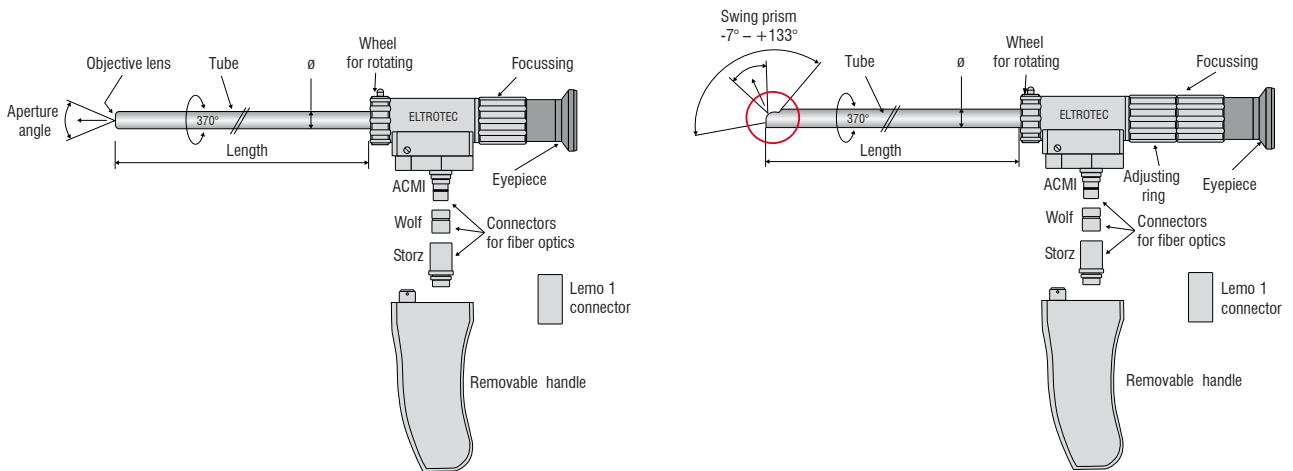

- The complete metal construction being composed of a stainless steel tube, main section, eyepiece and the handle from hardened, anodized aluminum ensure a long service life
- High quality and low maintenance due to precision mechanism

- Precisely coordinated components produce excellent focusing characteristics
- With swing prism endoscopes the prism is moved using a Bowden cable system for different direction views.

## 2 Components of Flexible Endoscopes

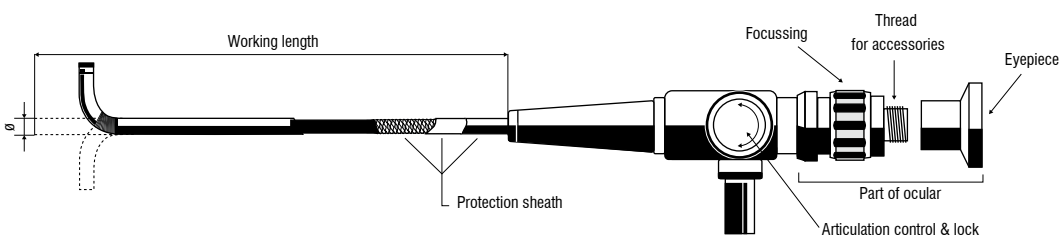

With flexible endoscopes, the fiber bundle comprises up to 30,000 individual fibers. Each fiber transmits one pixel from the lens to the eyepiece. Here the light points are combined to form the final image. In order to do this the fibers must have the same geometrical arrangement at the start and finish in order to ensure a distortion-free image. For an intensive and homogeneous illumination of the objects, glass fibers are arranged geometrically around the lens.

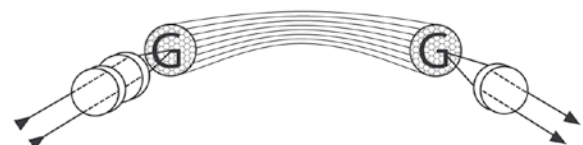

### 3 Optical Systems

- Each endoscope includes special lens systems calculated by computer software
- Optimal optical values and the best image quality due to rod lenses, achromatic or mixed systems
- In order to compensate for the disadvantage of low light conduction at small diameters, rod-lens systems are used.
- With an outer diameter of 5.8 mm and higher, achromatic lens systems are used. As a result the glass components in the endoscope can be optimized in favor of greater durability while maintaining the same optical characteristics

Rod lens system

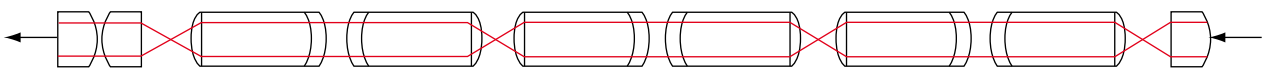

Objective

Achromatic system



Objective

GRIN lens system

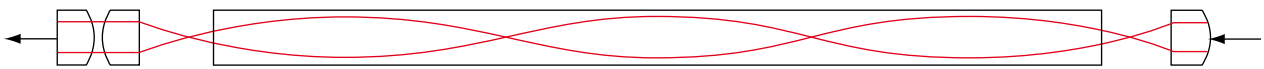

Objective

### 4 Direction of View

- All endoscopes are available with different directions of view
- The direction of view is the deviation of the central ray from the axis of the optical system

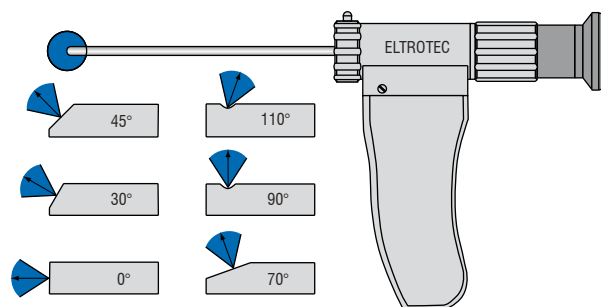

#### Swing Prism

- Using a swing prism, an individually adjustable direction of view from  $-7^\circ$  to  $+133^\circ$  (incl. aperture angle) is possible
- Total swivel range of  $140^\circ$
- Forward and retrograde view possible.

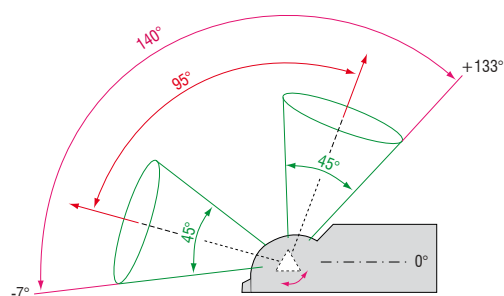

## 5 Aperture Angle

- Depending on the endoscope, different aperture angles are available
- Wide angles are achieved with both straight and deflected viewing directions

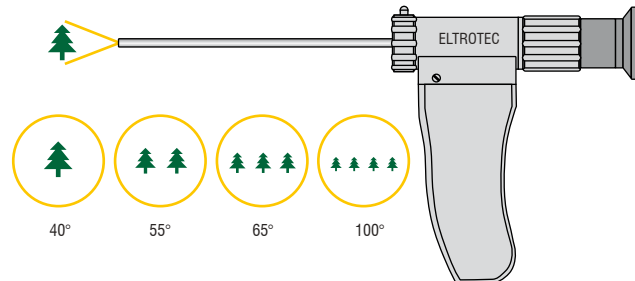

## 6 Illumination

- In order to generate bright images, the relationship between the glass fiber component and the diameter of the lens has been optimized which ensures the best possible illumination
- A universal connector for ACMI, Wolf, Storz or Lemo is included as standard
- Due to specially coated glass fibers, the light is transported without loss.

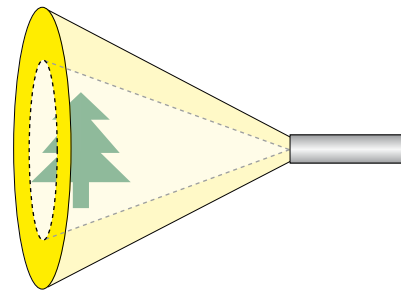

### For warm light sources the following applies:

- Illumination is provided by an incandescent light source (halogen) at the lens head. The output of the incandescent light source depends on the diameter, the greater the diameter the greater the light source output (as standard 100 watts at a  $\varnothing$  of 25mm)
- Through the use of incandescent light sources it is possible to illuminate larger cavities than with glass fiber illumination
- Adjustment of brightness on the eyepiece tube, i.e. directly on the device without interrupting the inspection
- Small cavities or poor air circulation involve the risk of excessive heat development as a result of the light source output. In some cases damage to the endoscope can occur due to excessive illumination periods, or to the object due to low heat resistance.

## 7 Magnification

Due to the large depth of field of Eltrotec borescopes, the magnification factor can only be calculated when the distance to the object is known. The curves below illustrate the relationship between magnification factor and distance. The magnification is inversely proportional to the distance. This means that the magnification is twice as great at half the distance and vice versa.

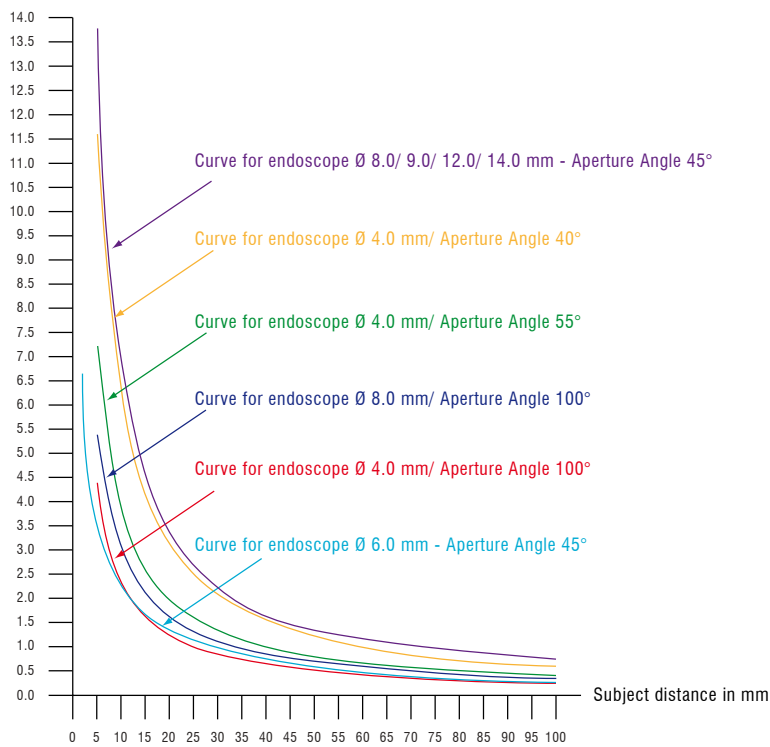

## Sensors and Systems from Micro-Epsilon



Sensors and systems for displacement, distance and position



Sensors and measurement devices for non-contact temperature measurement



Measuring and inspection systems for metal strips, plastics and rubber



Optical micrometers and fiber optics, measuring and test amplifiers



Color recognition sensors, LED analyzers and inline color spectrometers



Industrial endoscopes, light sources