

Fig. 1 Displacement sensor type - CA with integral cable

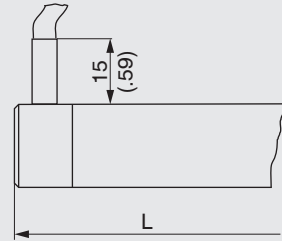

Fig. 2 Displacement sensor type - CR with integral (radial) cable

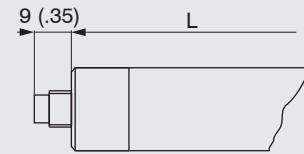

Fig. 3 Displacement sensor type - SA with axial plug connection

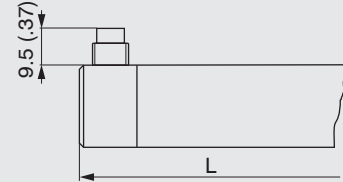

Fig. 4 Displacement sensor type - SR with radial plug connection

Basis model		DTA-15D-x-					DTA-25D-x-				
Connection		LA	CA	CR	SA	SR	LA	CA	CR	SA	SR
Length of housing L	mm (inches)	92.5 (3.64)	106.5 (4.19)	106.5 (4.19)	106.5 (4.19)	106.5 (4.19)	129.5 (5.10)	143.5 (5.65)	143.5 (5.65)	143.5 (5.65)	143.5 (5.65)
Length of plunger l ¹ in zero position	mm (inches)	51 (2.01)	51 (2.01)	51 (2.01)	51 (2.01)	51 (2.01)	62 (2.44)	62 (2.44)	62 (2.44)	62 (2.44)	62 (2.44)
Housing diameter	mm (inches)	20 (0.79)									

Fig. 5 Housing dimensions for displacement sensors with ±15 mm measuring range

Dimensions in mm (inches), not to scale

1) Plunger in zero position (±10 % of measuring range ±1 mm)

Pin Assignment

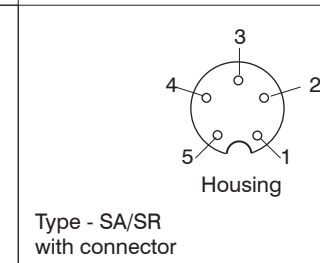
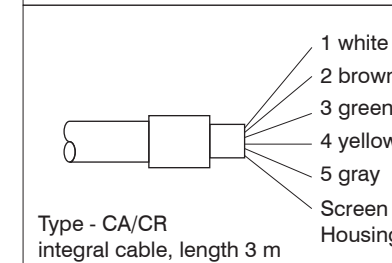
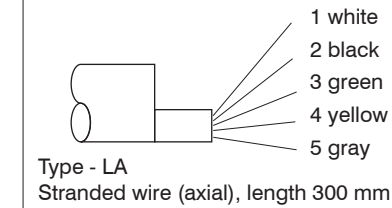
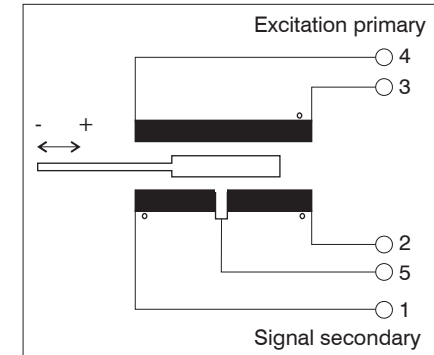

Assembly Instructions
induSENSOR,
DTA (LVDT) Series



Warnings

Avoid shocks and impacts to the sensor.

> Damage to or destruction of the sensor and/or the plunger

Excitation voltage and excitation frequency must comply with the requirements for the sensor.

> Damage to or destruction of the sensor

i Please use a suitable MSC7401, MSC7802, MSC7602 controller with corresponding excitation voltage and excitation frequency to operate the sensor.

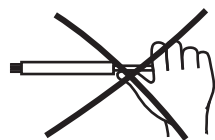

Protect the sensor cable against damage.

> Destruction of the sensor

> Failure of the measuring device

Do not carry the sensor on the plunger.

> Damage to the plunger

Notes on CE Marking

Inductive displacement sensors based on the LVDT principle are devices (components) which cannot be operated autonomously. Neither an EU Declaration of Conformity nor a CE marking are thus required according to the EMC law.

Sources: EMVG (Electromagnetic Compatibility Act), Guidelines on the application of directive 2014/30/EU. The sensors were EMC tested together with the MSC7401, MSC7802 and MSC7602 controllers.

Proper Environment

- Protection class:
 - Displacement sensor type TA, SA, LA, SR: IP40 / IP67¹
 - Displacement sensor type CA, CR: IP67
- Temperature range:
 - Operation: -20 ... +80 °C (-4 ... +176 °F)
 - Storage: -40 ... +80 °C (-40 ... +176 °F)
- Humidity: 5 - 95 % (non-condensing)
- Ambient pressure: Atmospheric pressure

1) Depends on used mating connector

Installation and Assembly

Precautions

Do not drop the free moving plunger of an inductive displacement sensor. Protect the cable sheath of the sensor cable from sharp edges and pointed or heavy objects. Do not bend more tightly than bending radius of the sensor cable. Avoid folding the cables.

➡ Check the plug connections for firm.

Sensor Mounting

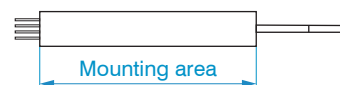

Fig. 6 Mounting of displacement sensors

Peripheral Clamping

➡ Use peripheral clamping on the sensor housing to mount the sensor.

This offers the highest reliability because the sensor is clamped over a board area by its cylindrical housing.

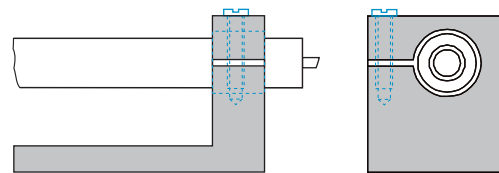

Fig. 7 Mounting of displacement sensors with peripheral clamping

Radial Point Clamping

➡ Mount the sensor using radial point clamping with set screws at installation locations where there are no forces and vibrations.

Plastic grub screw

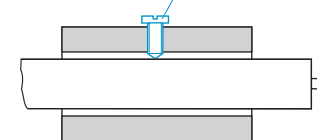

Fig. 8 Mounting of displacement sensors with radial point clamping

Plastic set screws must be used so that the sensor housing is not damaged or deformed.

Mounting the Plunger on the Measurement Object

➡ Screw the plunger of the displacement sensor to the measurement object using the thread.

The screw joint must either be secured with a screw locking compound (e.g. Loctite) or counter-screwed with the lock-nut supplied.

i When mounting, it must be ensured that the plunger remains freely movable in the sensor and that tilting is avoided.

Dimensional Drawings

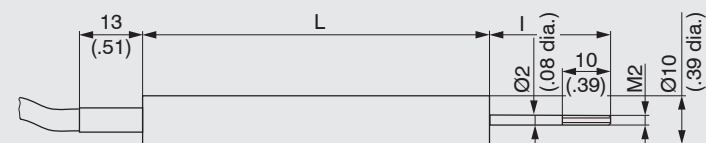

Fig. 9 Displacement sensor type - CA with integral cable

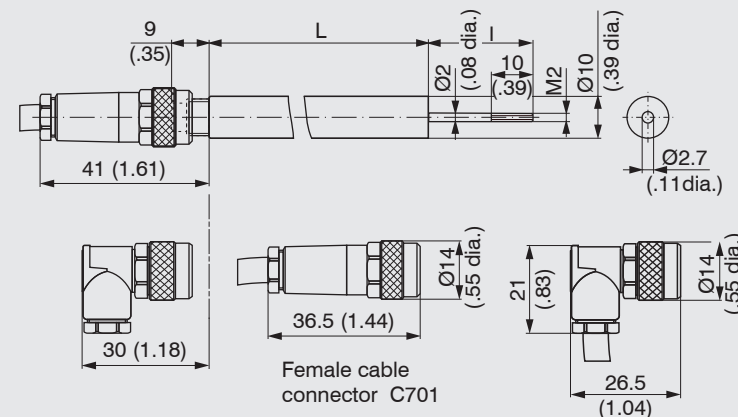

Fig. 10 Displacement sensor type - SA with axial plug connection

Dimensions in mm (inches), not to scale

Connecting the Sensor to the Controller

➡ Connect the sensor (depending on the respective model) to the controller using plug connectors or wire terminals (see pin assignment).

➡ Readjust the controller when replacing the sensor!

➡ If required, use the suitable ferrule.

Ready-made connecting cables are available as accessories for sensors with plug connector.

Basic model		DTA-1D-x	DTA-3D-x	DTA-5D-x	DTA-10D-x					
Connection		CA	SA	CA	SA	CA	SA	LA	CA	SA
Length of housing L	mm (inches)	40 (1.57)	40 (1.57)	57 (2.24)	57 (2.24)	73 (2.87)	73 (2.87)	78 (3.07)	87 (3.43)	87 (3.43)
Length of plunger l ¹ in zero position	mm (inches)	19 (0.75)	19 (0.75)	29 (1.14)	29 (1.14)	30 (1.18)	30 (1.18)	35 (1.38)	35 (1.38)	35 (1.38)
Housing diameter	mm (inches)	10 (.39)								

Fig. 11 Housing dimensions for displacement sensors up to ±10 mm measuring range

1) Plunger in zero position (±10 % of measuring range ±1 mm)

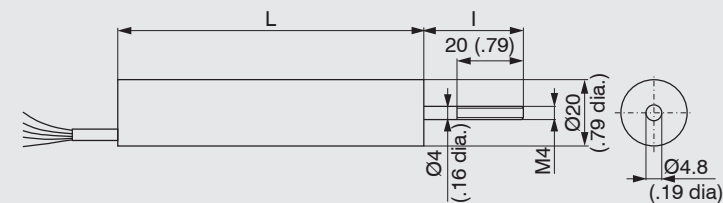

Fig. 12 Displacement sensor type - LA with axial stranded wire