

Operating Instructions

induSENSOR DTD / MSC7401 / 7802 / 7602

MSC7401
MSC7401(0x0)

MSC7602

MSC7802
MSC7802(0x0)

DTD

Miniature sensor controller for inductive displacement sensors

MICRO-EPSILON
MESSTECHNIK
GmbH & Co. KG
Koenigbacher Str. 15

94496 Ortenburg / Germany

Phone +49 (0) 8542 / 168-0
Fax +49 (0) 8542 / 168-90
e-mail info@micro-epsilon.com
www.micro-epsilon.com

Contents

1.	Safety	7
1.1	Symbols Used	7
1.2	Warnings	7
1.3	Notes on CE Marking	8
1.4	Intended Use	8
1.5	Proper Environment	9
2.	Functional Principle, Technical Data	10
2.1	Functional Principle	10
2.2	Structure	11
2.3	Technical Data	12
3.	Delivery	14
3.1	Unpacking/Included in Delivery	14
3.2	Storage	14
4.	Installation and Assembly	15
4.1	Precautions	15
4.2	Controller	16
4.2.1	DTD Model	16
4.2.2	MSC7401 Model	17
4.2.3	MSC7802 Model	20
4.2.4	MSC7602 Model	23
4.3	Power Supply, Sensor and Signal Output DTD (LVDT)	26
4.4	Power Supply, Sensor and Signal Output MSC7401	27
4.4.1	Power Supply and Signal	30
4.4.2	Digital Interface	31
4.4.3	Sensor	32
4.5	Power Supply, Sensor and Signal Output MSC7802	34
4.5.1	Power Supply and Signal	37
4.5.2	Digital Interface	38
4.5.3	Sensor	39
4.6	Power Supply, Sensor and Signal Output MSC7602	41
4.6.1	Power Supply and Signal	42
4.6.2	Sensor	43
4.6.3	Digital Interface	44

5.	Operation	45
5.1	Initial Operation.....	46
5.2	Control and Display Elements.....	48
5.3	Setting.....	49
5.3.1	Automatic Sensor Recognition.....	50
5.3.2	Signal	50
5.3.3	Sensor Parameters.....	51
5.3.4	Adjustment.....	52
5.4	Menu Structure	53
5.4.1	Two-point Adjustment.....	56
5.4.2	Zero-point Adjustment.....	57
5.4.3	Example A: Sensor Parameter Adjustment: DTA-5G8, Channel 1	58
5.4.4	Example B: Signal Output Adjustment: 2 ... 10 V, Channel 1	59
5.4.5	Example C: Adjustment via Zero-point Adjustment, Channel 1	60
5.4.6	Example D: Adjustment via Two-point Adjustment, Channel 1	61
5.5	Multi-Channel Operation.....	62
5.5.1	Operation on the RS485 Bus with Multiple Channels.....	63
5.5.2	Synchronization and Installation of Multiple Channels.....	65
6.	Service, Repair	67
7.	Disclaimer	68
8.	Decommissioning, Disposal	69

Appendix

A 1	Optional Accessories	70
A 2	Factory Settings	72
A 3	Software	73
A 3.1	Controller Search.....	73
A 3.2	Configure Baudrate	74
A 3.3	Menu Settings.....	75
A 3.3.1	General	75
A 3.3.2	Output.....	77
A 3.3.3	Adjustment.....	79
	A 3.3.3.1 Two-point Adjustment	79
	A 3.3.3.2 Zero-point Adjustment	82
A 3.4	Measurement Menu.....	85
A 3.4.1	Data Acquisition.....	86
A 3.4.2	Signal Processing.....	87
A 3.4.3	CSV Output.....	88
A 3.4.4	Description Data Acquisition Table	89
A 3.5	Single Value Menu.....	90
A 3.6	Info Menu	91
A 3.7	Multi-Sensor DAQ Mode.....	93
A 4	Communication via RS485 Digital Interface	97
A 4.1	General	97
A 4.2	Hardware Configuration	97
A 4.3	Protocol.....	97
A 4.4	Commands	98
A 4.4.1	Identification	98
A 4.4.2	Assign New Address	99
A 4.4.3	Reset	99
A 4.4.4	Get Measuring Value	100

1. Safety

Sensor operation assumes knowledge of the operating instructions.

1.1 Symbols Used

The following symbols are used in these operating instructions:



Indicates a hazardous situation which, if not avoided, may result in minor or moderate injury.



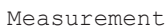
Indicates a situation that may result in property damage if not avoided.



Indicates a user action.



Indicates a tip for users.



Indicates hardware or a software button/menu.

1.2 Warnings



Connect the power supply and the display/output device according to the safety regulations for electrical equipment.

> Risk of injury

> Damage to or destruction of the controller and/or the sensor



Avoid shocks and impacts to the sensor and controller.

> Damage to or destruction of the controller and/or the sensor

The supply voltage must not exceed the specified limits.

> Damage to or destruction of the controller and/or the sensor

Protect the sensor cable against damage.

- > Destruction of the sensor
- > Failure of the measuring device

No sharp or heavy objects should be allowed to affect the cables. Avoid folding the cables.

- > Damage or destruction of the cable, failure of the measuring device

1.3 Notes on CE Marking

The following apply to the induSENSOR DTD / MSC7401 / 7802 / 7602 series:

- EU Directive 2014/30/EU
- EU Directive 2011/65/EU

Products which carry the CE mark satisfy the requirements of the EU directives cited and the relevant applicable harmonized European standards (EN). The measuring system is designed for use in industrial environments.

The EU Declaration of Conformity and the technical documentation are available to the responsible authorities according to EU Directives.

1.4 Intended Use

- Das induSENSOR DTD / MSC7401 / 7802 / 7602 measuring system is designed for use in industrial environments. It is used to control inductive displacement sensors based on the LVDT principle (Linear Variable Differential Transformer) and for operation with LDR displacement sensors.
- The system must only be operated within the limits specified in the technical data, [see 2.3](#).
- The system must be used in such a way that no persons are endangered or machines and other material goods are damaged in the event of malfunction or total failure of the system.
- Take additional precautions for safety and damage prevention in case of safety-related applications.

1.5 Proper Environment

- Protection class (only controller):
 - DTD: IP67 (plugged)
 - MSC7401 and 7802: IP67 (plugged)
 - MSC7602: IP20
- Temperature range:
 - Operation: -40 ... +85 °C (-40 ... +185 °F)
 - Storage: -40 ... +85 °C (-40 ... +185 °F)
- Humidity: 5 ... 95 % (non-condensing)
- Ambient pressure: Atmospheric pressure
- Shock: EN 60068-2-27
- Vibration: EN 60068-2-6

2. Functional Principle, Technical Data

2.1 Functional Principle

The DTD / MSC 7401 / 7802 / 7602 series are single- and multi-channel miniature sensor controllers for the operation of inductive displacement sensors based on the LVDT principle (full bridge) and for half-bridge sensors.

An electronic oscillator supplies the primary coil with an alternating current of constant frequency and amplitude. For optimal control of the respective sensors, the frequency and the supply voltage can be set, [see 5](#).

The demodulator electronics transforms the signal of the two (secondary) coils into the set output signal. With the setting possibilities for zero point and gain, the user can adapt the equipment to the task to be performed, [see 5](#).

The output signal increases, when the plunger is moved into the sensor. If the reverse effective direction is required (i.e. the signal becomes smaller when the plunger is inserted), replace the connections Secondary + and Secondary -, or make the according setting in the controller, [see 5.3.4](#).

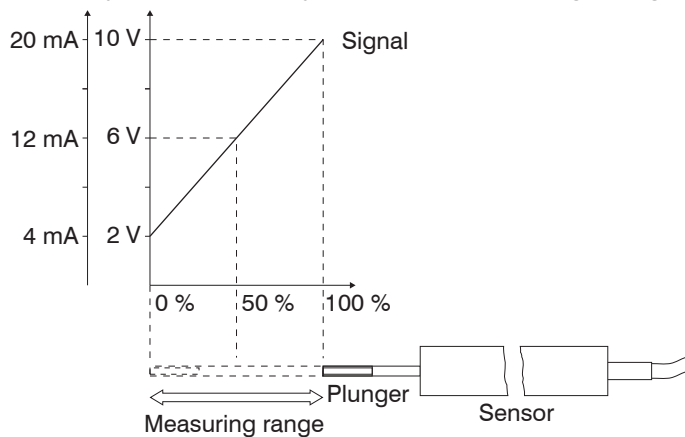


Fig. 1 Measuring principle

2.2 Structure

A complete measuring channel consists of

- Sensor and controller (DTD, MSC7401 model)
- Two sensors and controllers (MSC7802 / 7602 models)
- Sensor cable
- Supply and output cable

Any type of half-bridge and full-bridge sensors can be connected to the amplifier electronics. However, if sensors of other manufacturers are used you should check their functionality in conjunction with the controller. MICRO-EPSILON recommends the inductive displacement sensors and gauging sensors of the induSENSOR DTA and LDR series because they are optimally adjusted with the controller.

2.3 Technical Data

Model	DTD	MSC7401	MSC7802	MSC7602
Resolution ¹	DTA series	13 bit (0.012 % FSO) with 50 Hz 12 bit (0.024 % FSO) with 300 Hz		
	LDR series	-	12 bit (0.024 % FSO) with 50 Hz 11 bit (0.048 % FSO) with 300 Hz	
Frequency response (-3 dB)	300 Hz (adjustable only via software)			
Linearity	$\leq \pm 0.02$ % FSO			
Temperature stability	DTA series	≤ 100 ppm FSO / K		
	LDR series	-	≤ 125 ppm FSO / K	
Supply voltage	14 ... 30 VDC (5 ... 30 VDC ²)			
Max. current consumption	40 mA		80 mA	
Input impedance ³	-	> 100 kOhm		
Digital interface	RS485 / PROFINET ⁴ / EtherNet/IP ⁴ / Ethernet ⁴ / EtherCAT ⁴		RS485 / PROFINET ⁴ / EtherNet/IP ⁴	
Analog output ²⁵	(0)2 ... 10 V; 0.5 ... 4.5 V; 0 ... 5 V ($R_a > 1$ kOhm) or 0(4) ... 20 mA (load < 500 Ohm)			
Connection	Supply / signal: 5-pin M12 plug-in connector (cable, optional accessories, see A 1)	Sensor: screw terminal AWG 16 up to AWG 24; with ferrule up to AWG 28 or 5-pin M9 connector (cable, optional accessories, see A 1) Supply/signal: screw terminal AWG 16 up to AWG 24; with ferrule up to AWG 28 or 5-pin M12 connector (cable, optional accessories, see A 1)	Sensor: screw terminal AWG 16 up to AWG 28 Supply/signal: screw terminal AWG 16 up to AWG 28 Supply/Sync/RS485: Mountain rail bus connector	
Installation	Circumferential clamping ⁶	2 x mounting holes for M4		DIN rail 35 mm
Temperature range	Storage	-40 ... +85 °C (-40 ... 185 °F)		
	Operation	-40 ... +85 °C (-40 ... 185 °F)		

Modell	DTD	MSC7401	MSC7802	MSC7602
Shock (DIN-EN 60068-2-27)	40 g / 6 ms in 3 axes, 2 directions and 1000 shocks each 100 g / 5 ms in 3 axes, 2 directions and 9 shocks each			5 g / 6 ms in 6 axes, 1000 shocks each 15 g / 11 ms in 6 axes, 10 shocks
Vibration (DIN-EN 60068-2-6)	± 1.5 mm / 5 ... 57 Hz in 3 axes, 10 cycles each ± 20 g / 57 ... 500 Hz in 3 axes, 10 cycles each			± 2 mm / 10 ... 15.77 Hz in 3 axes, 10 cycles each ± 2 g / 15.77 ... 2000 Hz 3 axes, 10 cycles each
Protection class (DIN-EN 60529)	IP67 (plugged)			IP20
Material	Stainless steel	Aluminum die casting		Polyamide
Weight	approx. 50 g	approx. 200 g	approx. 280 g	approx. 120 g
Compatibility	Full-bridge sensor/ LVDT (DTA series)	Full-bridge sensor/LVDT (DTA series) and half-bridge sensor (LDR series)		
No. of measurement channels	1	1	2	2
Power supply protection	Reverse polarity protection, overvoltage protection			
Sensor excitation ⁷	Preset at factory, cannot be changed	-550 mV _{pp} , 350 mV _{pp} , 150 mV _{pp} , 75 mV _{pp} 1, 2, 5, 10, 13 kHz (DTA) / 9, 13, 16, 21, 23 kHz (LDR)		
Gain	Determination by 2 points of a straight line of the output signal with respect to the target position. The distance between the two points must be greater than 10 % of the measuring range. Adjustable via buttons (MSC series) and software (all series)			
Zero				
EMC	DIN EN 61326-1; DIN EN 61326-2-3			

FSO = Full scale Output

1) Noise: AC RMS measurement via RC low-pass filter of the 1st order with $f_c = 5$ kHz

2) $V_+ = 5$ V: no voltage output available; current output: max. load 100 Ω ; $V_+ = 9$ V: voltage output: 0.5 V ... 4.5 V or 0 V ... 5 V; current output: max. load 250 Ω

3) Sensor side

4) Connection via interface module, optional accessories, [see A 1](#)

5) With controllers including a current output, the output signal is limited to approx. 21 mA.

6) Mounting clamp included in delivery, [see 3.1](#)

7) Adjustable via buttons; via software, additional steps can be adjusted under frequency.

3. Delivery

3.1 Unpacking/Included in Delivery

1 Controller

1 Assembly instruction

1 Mounting bracket (for induSENSOR model DTD)

2 Sleeve-shaped ferrites and 2 fastening clips for M4 screw (with induSENSOR MSC7602 model)

➡ Carefully remove the components of the measuring system from the packaging and ensure that the goods are forwarded in such a way that no damage can occur.

➡ Check the delivery for completeness and shipping damage immediately after unpacking.

➡ If there is damage or parts are missing, immediately contact the manufacturer or your supplier.

Optional accessories are listed in the appendix, [see A 1](#).

3.2 Storage

Temperature range (storage): -40 ... +85 °C (-40 ... +185 °F)

Humidity: 5 ... 95 % (non-condensing)

4. Installation and Assembly

4.1 Precautions

No sharp or heavy objects should be allowed to affect the cable sheath of the sensor cable or the supply/output cable. Avoid folding the cables


> Damage to or destruction of the sensor cable and/or controller

Do not bend more tightly than the minimum bending radius of the cables.


> Damage or destruction of the cables

> Failure of the measuring device

 Check all plug-in connections for firm seating before starting operation.

 Ensure careful handling during installation and operation.

In addition with the DTD model:

 Avoid cyclic movements of the crimps and ferrite of the sensor cable. In the case of cyclic movements (e.g. use in a drag chain), fix the sensor cable additionally with suitable means.

4.2 Controller

4.2.1 DTD Model

- ➡ When mounting the controller, use the mounting clamp included in delivery, [see 3.1](#), as well as a suitable M3 screw.

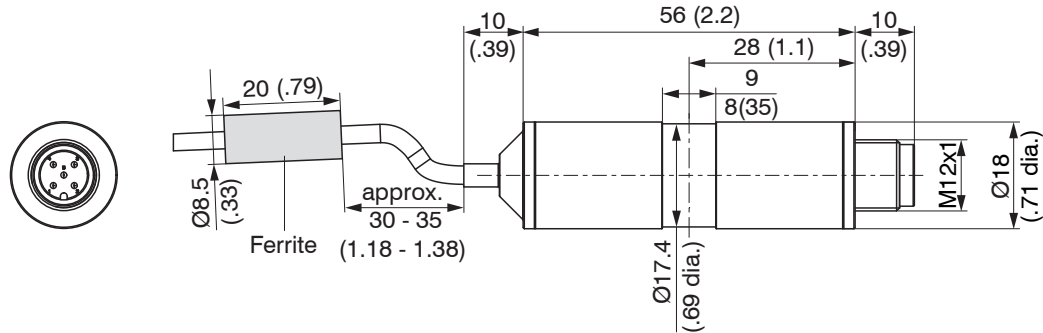


Fig. 2 Dimensional drawing of DTD controller, dimensions in mm (inches)

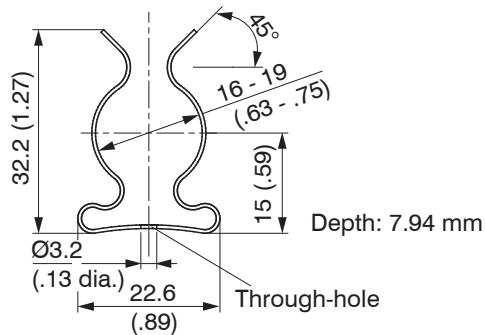


Fig. 3 Dimensional drawing of mounting clamp, dimensions in mm (inches)

4.2.2 MSC7401 Model

 Fasten the controller of series MSC7401 by means of two M4 screws.

The position of the mounting holes is shown in the drawing, [see Fig. 4](#).

The tightening torque for the cover screws is 0.9 Nm. The maximum tightening torque for the SW15 (M12) cable gland is 1.5 Nm and for the SW19 (M16) cable gland is 3 Nm.

Please note that less torque should be applied for cable glands with various cable sheath materials.

> Damage to the cable sheath

NOTICE

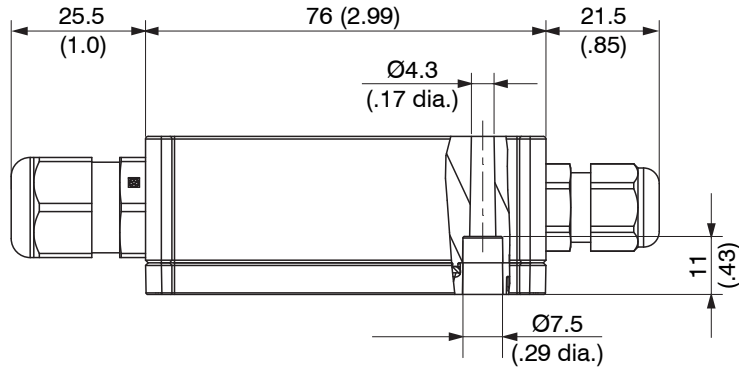
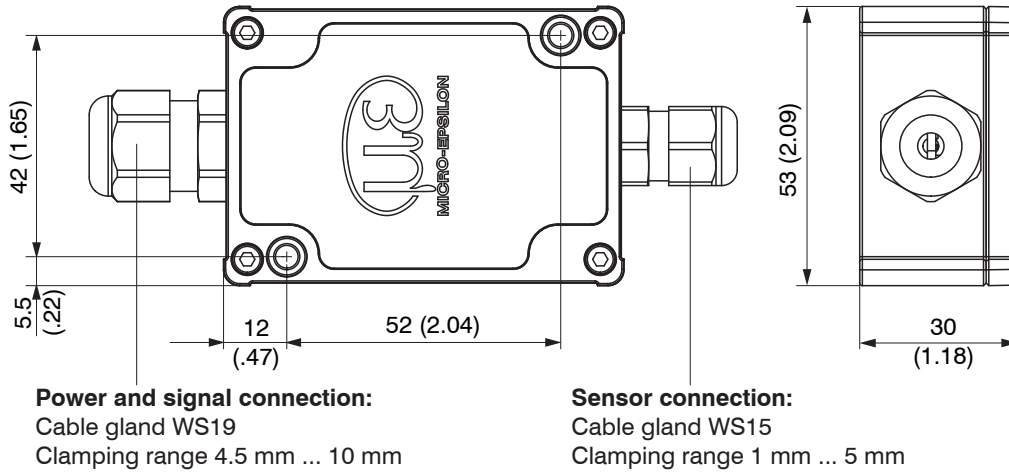
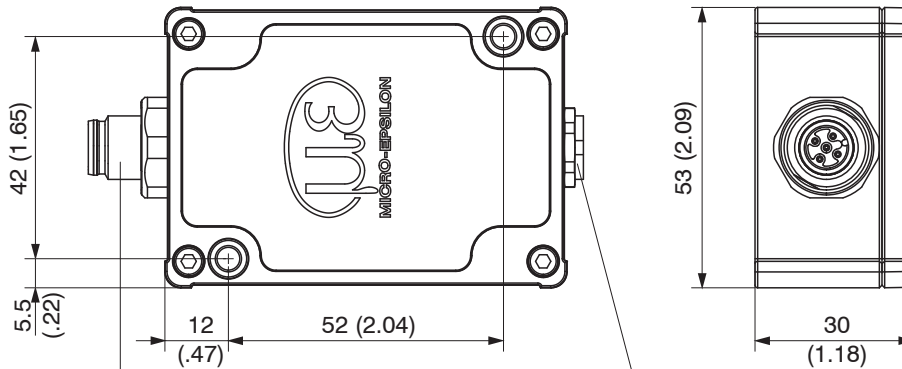


Fig. 4 Dimensional drawing of MSC7401 controller, dimensions in mm (inches)



Power and signal connection
M12x1 plug; 5-pole

Sensor connection:
M9 5-pole socket
Series 712 (Binder)

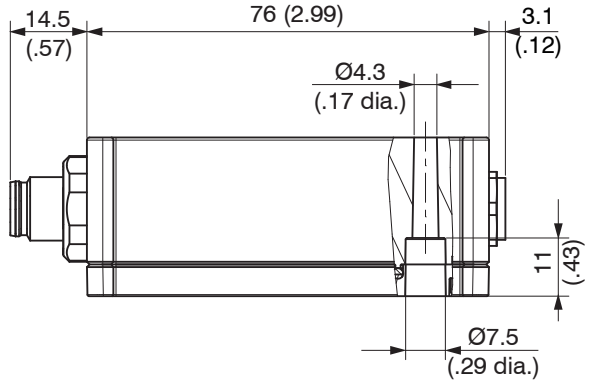


Fig. 5 Dimensional drawing of MSC7401(010) controller, dimensions in mm (inches)

4.2.3 MSC7802 Model

Fasten the controller of series MSC7802 by means of two M4 screws, [see Fig. 6](#).

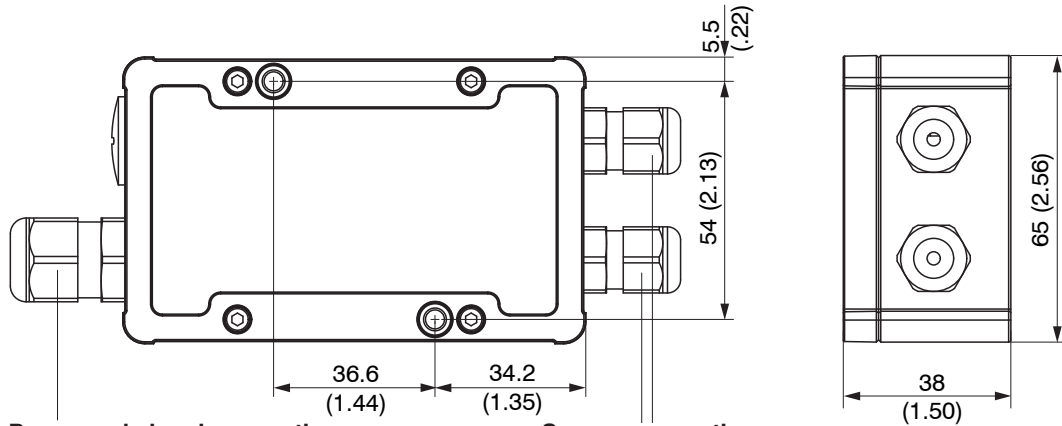
The position of the mounting holes is shown in the drawing, [see Fig. 6](#).

The tightening torque for the cover screws is 0.9 Nm. The maximum tightening torque for the SW15 (M12) cable gland is 1.5 Nm and for the SW19 (M16) cable gland is 3 Nm.

Please note that less torque should be applied for cable glands with various cable sheath materials.

> Damage to the cable sheath

NOTICE



Power and signal connection:

Cable gland WS19

Clamping range 4.5 mm ... 10 mm

Sensor connections:

Cable gland WS15

Clamping range 1 mm ... 5 mm

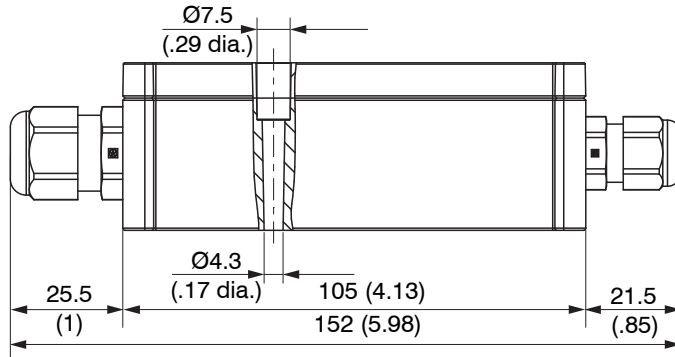
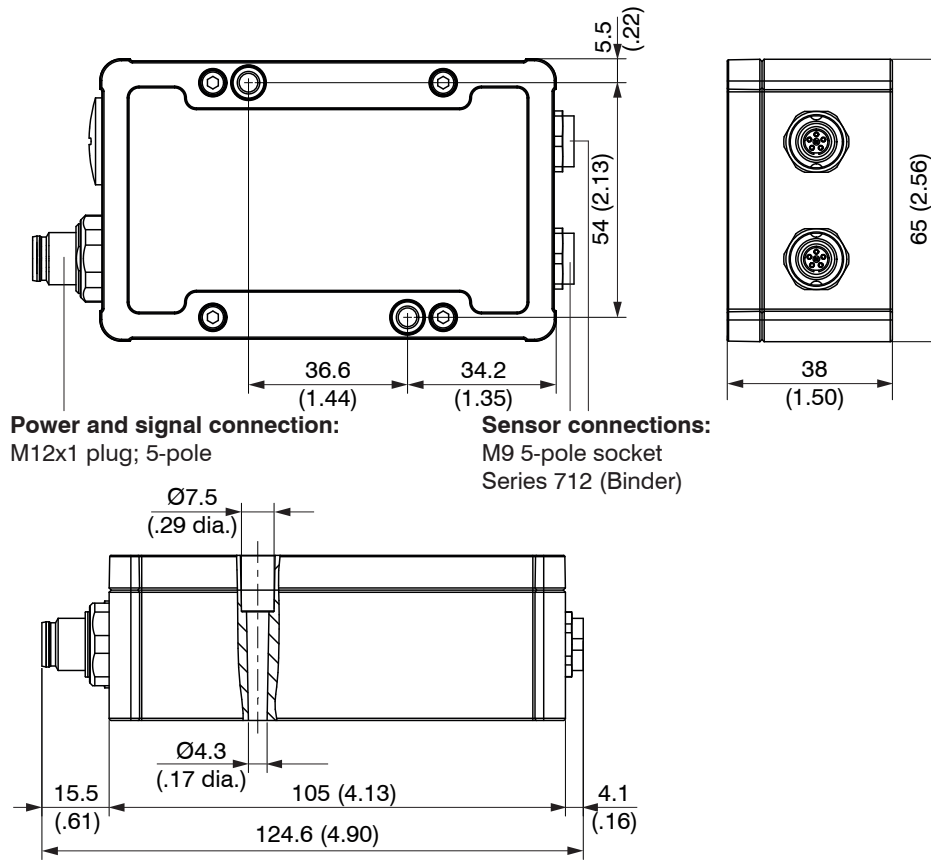


Fig. 6 Dimensional drawing of MSC7802 controller, dimensions in mm (inches)



Power and signal connection:
M12x1 plug; 5-pole

Sensor connections:
M9 5-pole socket
Series 712 (Binder)

Fig. 7 Dimensional drawing of MSC7802(010) controller, dimensions in mm (inches)

4.2.4 MSC7602 Model

- If required, install a DIN rail bus connector, e.g., ME22,5 TBUS 1,5/4P1S KMGY (Phoenix: 2201732), see A 1, onto the DIN rail.
- If required, connect the mating plug, e.g., MCVR 1.5/5-ST-3.81 (Phoenix: 1827156), see A 1, with the bus connector.
- Position the MSC7602 controller on the DIN rail and press it down until it snaps in, see Fig. 8.



Fig. 8 Installation of controller



Fig. 9 Dismantling of controller

Dismantling

- For dismantling, pull the locking element on the controller forwards, e.g., using a screwdriver ①, see Fig. 9.
- Tilt the controller in order to remove it from the DIN rail ②, see Fig. 9

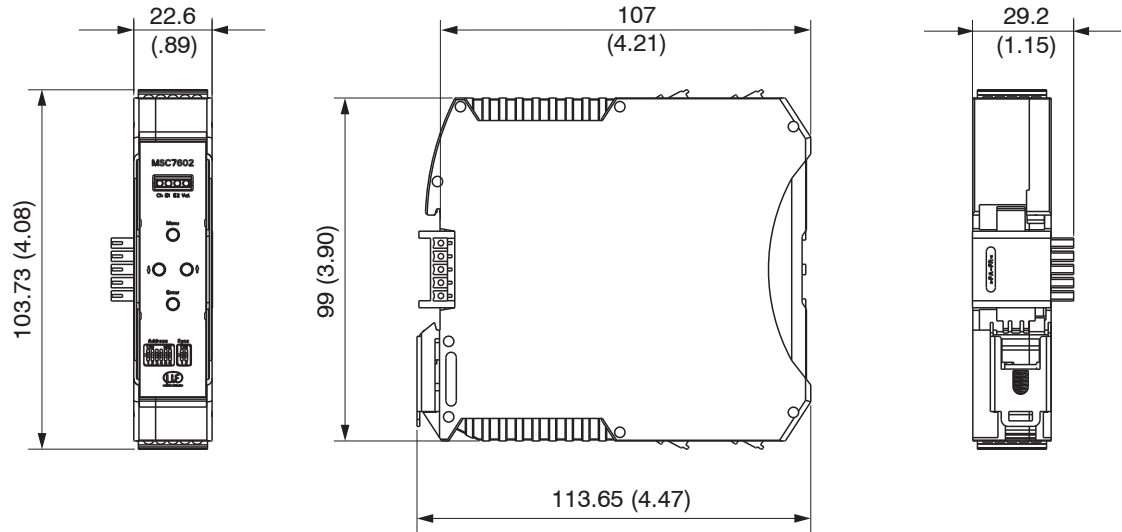


Fig. 10 Dimensions of MSC7602 controller model, dimensions in mm (inches)

Installation with ferrite

To stabilize the output signal against EMC interference, the sensor cables can be guided through a fastening clip with a sleeve-shaped ferrite (both included in delivery), [see 3.1](#).

This ferrite must be mounted as close as possible to the input terminals.

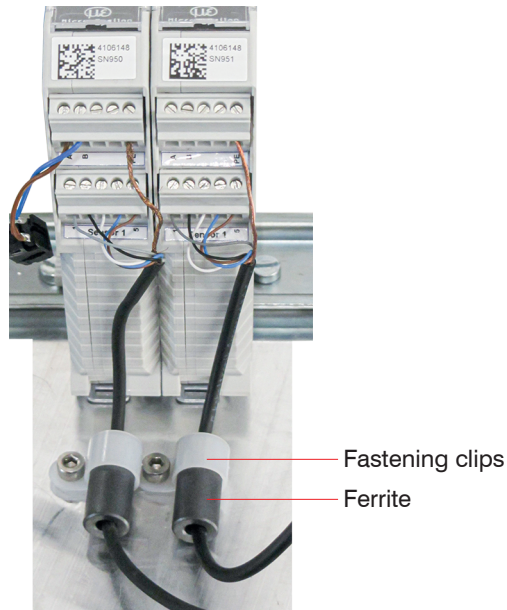


Fig. 11 Installation example of induSENSOR MSC7602 with ferrite

NOTICE

Avoid applying force on the terminals and the sensor cables.
> Damage to the sensor cables and/or the controller

4.3 Power Supply, Sensor and Signal Output DTD (LVDT)

The minimum bending radius of the PC5/5-IWT power supply and output cable (available as an optional accessory, [see A 1](#)) is ten times the cable diameter.

Connection on power supply/output side: 5-pin. M12x1 housing connector, A-coded



Fig. 12 View with plug-in connector, DTD (LVDT)

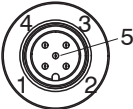
Pin	Assignment	Cable color (PC5/5-IWT)	
1	Supply voltage V_+	Brown	
2	RS485 - A	White	
3	GND	Blue	
4	Signal out	Black	
5	RS485 - B	Gray	
			5-pin. M12x1 housing connector M12x1 (A-coded, view on pole side)

Fig. 13 Table for pin assignment for power supply and signal

4.4 Power Supply, Sensor and Signal Output MSC7401

The minimum bending radius of the PC7400-6/4 and PC5/5-IWT power supply and output cables (available as optional accessories, [see A 1](#)) is ten times the cable diameter. All of the connections for the power supply/sensors/signal output are on the controller, [see Fig. 14](#), [see Fig. 15](#).

Connections

- Power supply/output side:
 - Cable gland: SW19; clamping range 4.5 mm ... 10 mm
Screw terminal connection; AWG 16 up to AWG 24; up to AWG 28 with ferrule
 - Alternatively: connector M12x1, 5-pole, A-coded
- Sensor side:
 - Cable gland: SW15; clamping range 1 mm ... 5 mm
Screw terminal connection; AWG 16 up to AWG 24; up to AWG 28 with ferrule
 - Alternatively: female connector M9; 5-pole, series 712, Co. Binder



Fig. 14 View with cable gland, MSC 7401



Fig. 15 View with plug-in connectors, MSC 7401(010)

Wiring

The housing must be open to connect the sensors, [see 4.4.3](#) and wire the output and power supply cable, [see 4.4.1](#).

- ➡ Loosen the screws.
- ➡ Pass the sensor and signal cables through the cable glands.
- ➡ Connect the cables to the terminals according to the pin assignments.

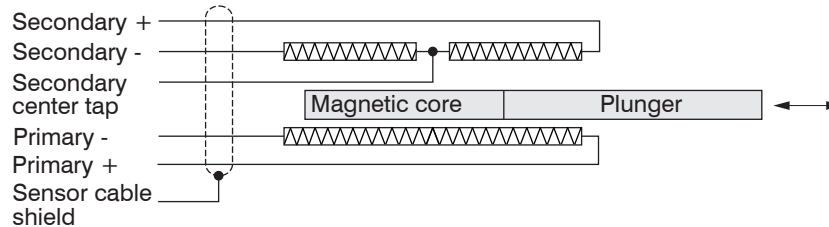


Fig. 16 Pin assignment for the sensor at terminal block X2, full bridge

Terminal block X2	Pin	Cable ¹ DTA-x-CA-x DTA-x-CR-x C701-x	Braid ¹ DTA-x-LA-x	Solder pin ¹ DTA-x-TA-x	Cable ¹ DTA-xG8-x
Shield (sensor cable)	1	Shield	-	-	Shield
Secondary center tap	2	Gray	Gray	5	Gray
Secondary +	3	White	White	1	Black
Secondary -	4	Brown	Black	2	White
Primary +	5	Green	Green	3	Blue
Primary -	6	Yellow	Yellow	4	Brown

Fig. 17 Table of the pin assignment for the sensor at terminal block X2, full bridge

1) The colors and pins listed refer to the sensors from MICRO-EPSILON MESSTECHNIK GmbH & Co. KG.

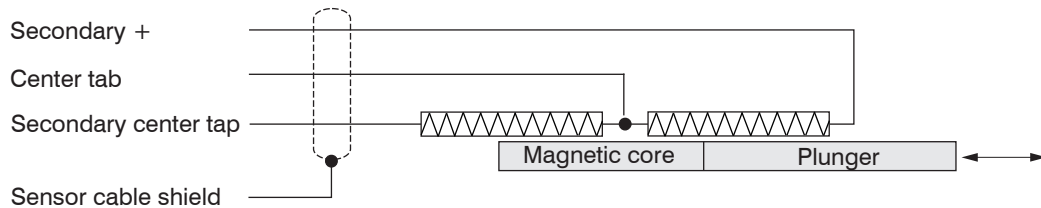


Fig. 18 Pin assignment for the sensor at terminal block X2, half bridge

Terminal block X2	Pin	Cable ¹ LDR-x-CA LVP-25-20-x	Connector LDR-x-SA	Sensor cable ¹ C7210-x
Shield (sensor cable)	1	-	-	-
Secondary center tap	2	Green	4	Black
Secondary +	3	White	1	Brown
Secondary -	4	Brown	3	Blue
Primary +	5	-	-	-
Primary -	6	-	-	-

Fig. 19 Table of the pin assignment for the sensor at terminal block X2, half bridge

The pin assignment for the terminal blocks can also be found in the graphic and the tables, [see Fig. 20 ff.](#)

1) The colors and pins listed refer to the sensors from MICRO-EPSILON & Co. KG.

4.4.1 Power Supply and Signal

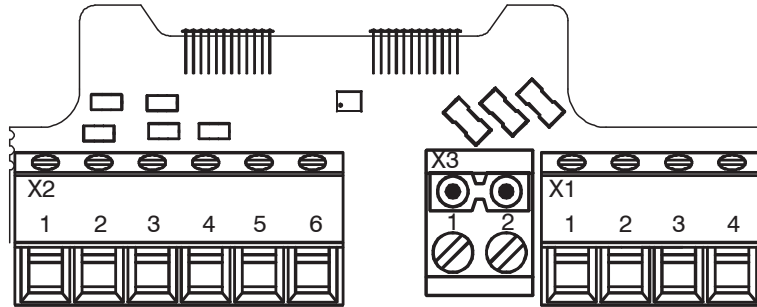


Fig. 20 Pin assignment for supply and signal on the terminal blocks X2, X3, X1

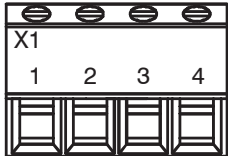
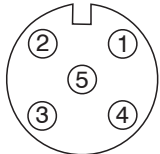
Pin assignment of supply and analog output	Variant with cable gland		Connector variant	
			 <p>5-pin M12x1 housing connector (A-coded; view on pin side)</p>	
Assignment	Pin X1	Color (cable: PC7400-6/4)	5-pin	Color (cable: PC5/5-IWT)
Analog output	1	Yellow	4	Black
Supply voltage	2	White	1	Brown
GND supply/signal ground	3	Brown	3	Blue
Shield (housing)	4	Cable shield	-	Cable shield guided over connector
-	-	-	2	White
-	-	-	5	Gray

Fig. 21 Table for pin assignment of supply and analog output

4.4.2 Digital Interface

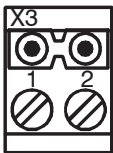
Assignment	Pin X3		Color (IF7001)
RS485 A	1		Brown
RS485 B	2		White

Fig. 22 Table for pin assignment of digital interface RS485

i Use the IF7001 single-channel USB/RS485 converter for MSC7xxx available as an optional accessory, [see A 1](#). Do not apply the IF7001 shield!

4.4.3 Sensor

The output signal increases, when the plunger is moved into the sensor. If the reverse effective direction is required (i.e. the signal becomes smaller when the plunger is inserted), replace the connections Secondary + and Secondary -.

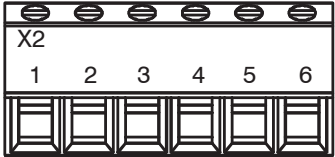
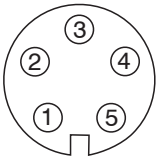
Sensor pin assignment (DTA/LVDT)	Variant with cable gland 				Connector  5-pin housing socket M9 (Binder, series 712) View on pin side
Assignment	Pin X2	DTA-x-CA-x DTA-x-CR-x Cable C701-x	DTA-x-CA-x	DTA-xG8-x	5-pin
Shield	1	Shield	-	Shield	Housing
Secondary center tap	2	Gray	Gray	Gray	5
Secondary +	3	White	White	Black	1
Secondary -	4	Brown	Black	White	2
Primary +	5	Green	Green	Blue	3
Primary -	6	Yellow	Yellow	Brown	4

Fig. 23 Table for pin assignment of sensor (DTA/LVDT)

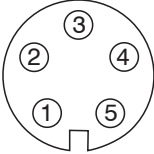
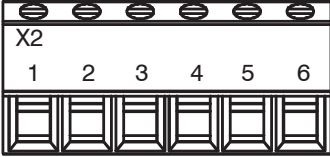
Sensor pin assignment (LDR)	Variant with cable gland			Connector  5-pin housing socket M9 (Binder, series 712) View on pin side
				
Assignment	Pin X2	LDR-x-CA LVP-25-Z20-x	Cable C7210-x	5-pin
Shield	1	-	-	Housing
Secondary center tap	2	Green	Black	5
Secondary +	3	White	Brown	1
Secondary -	4	Brown	Blue	2
Primary +	5	-	-	3
Primary -	6	-	-	4

Fig. 24 Table for pin assignment of sensor (LDR)

i Cable lengths ≥ 10 m between sensor and controller may impair the technical data, [see 2.3](#).

4.5 Power Supply, Sensor and Signal Output MSC7802

The minimum bending radius of the PC7400-6/4and PC5/5-IWT power supply and output cables (available as optional accessories), [see A 1](#), is ten times the cable diameter. All of the connections for the power supply/sensors/signal output are on the controller, [see Fig. 6](#).

Connections

- Power supply/output side:
 - Cable gland: SW19; clamping range 4.5 mm ... 10 mm
 - Screw terminal connection; AWG 16 up to AWG 24; up to AWG 28 with ferrule
 - Alternatively: Connector M12x1, 5-pole, A-coded
- Sensor side:
 - Cable gland: SW15; clamping range 1 mm ... 5 mm
 - Screw terminal connection; AWG 16 up to AWG 24; up to AWG 28 with ferrule
 - Alternatively: female connector M9; 5-pole, series 712, Co. Binder



Fig. 25 View with cable gland, MSC7802



Fig. 26 View with plug-in connectors, MSC7802(010)

Wiring

The housing must be open, [see 4.5.3](#), to connect the sensors and wire the output and power supply cable, [see 4.5.1](#).

- ➡ Loosen the screws.
- ➡ Pass the sensor and signal cables through the cable glands.
- ➡ Connect the cables to the terminals according to the pin assignments.

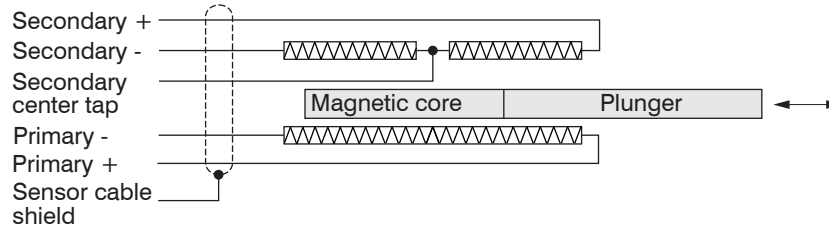


Fig. 27 Pin assignment for the sensor at terminal block X2, full bridge

Terminal block X2	Pin	Cable ¹ DTA-x-CA-x DTA-x-CR-x C701-x	Braid ¹ DTA-x-LA-x	Solder pin ¹ DTA-x-TA-x	Cable ¹ DTA-xG8-x
Shield (sensor cable)	1	Shield	-	-	Shield
Secondary center tap	2	Gray	Gray	5	Gray
Secondary +	3	White	White	1	Black
Secondary -	4	Brown	Black	2	White
Primary +	5	Green	Green	3	Blue
Primary -	6	Yellow	Yellow	4	Brown

Fig. 28 Table of the pin assignment for the sensor at terminal block X2, full bridge

1) The colors and pins listed refer to the sensors from MICRO-EPSILON MESSTECHNIK GmbH & Co. KG.

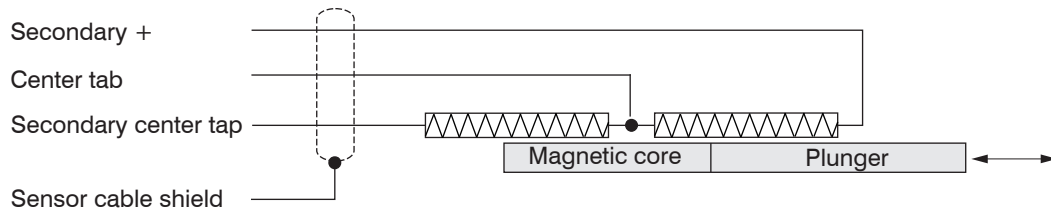


Fig. 29 Pin assignment for the sensor at terminal block X2, half bridge

Terminal block X2	Pin	Cable ¹ LDR-x-CA LVP-25-20-x	Connector LDR-x-SA	Sensor cable ¹ C7210-x
Shield (sensor cable)	1	-	-	-
Secondary center tap	2	Green	4	Black
Secondary +	3	White	1	Brown
Secondary -	4	Brown	3	Blue
Primary +	5	-	-	-
Primary -	6	-	-	-

Fig. 30 Table of the pin assignment for the sensor at terminal block X2, half bridge

The pin assignment for the terminal blocks can also be found in the graphic and the tables, see Fig. 31 ff.

1) The colors and pins listed refer to the sensors from MICRO-EPSILON MESSTECHNIK GmbH & Co. KG.

4.5.1 Power Supply and Signal

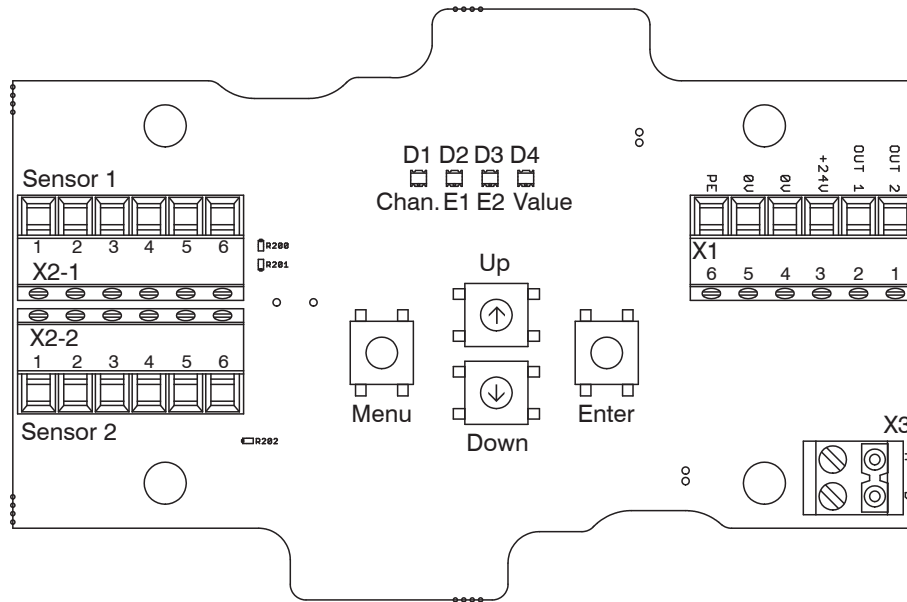


Fig. 31 Pin assignment for power supply and signal on the terminal blocks X2, X3, X1

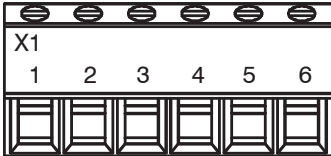
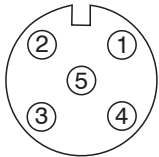
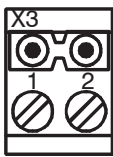
Pin assignment of supply and analog output	Variant with cable gland			Connector variant	
					
				5-pin M12x1 (A-coded); view on pin side	
Assignment	Pin X1	Color (cable: PC7400-6/4)	5-pin	Color (cable: PC5/5-IWT)	
Analog output for channel 2	1	Green	2	White	
Analog output for channel 1	2	Yellow	4	Black	
Supply voltage	3	White	1	Brown	
GND supply/signal ground	4	Brown	3	Blue	
-	5	-	5	Gray	
Shield (housing)	6	Cable shield	-	Cable shield guided over connector	

Fig. 32 Table for pin assignment of supply and analog output

4.5.2 Digital Interface

Assignment	Pin X3		Color (IF7001)
RS485 A	1		Brown
RS485 B	2		White

i Use the IF7001 single-channel USB/RS485 converter for MSC7xxx available as an optional accessory, [see A 1](#). Do not apply the IF7001 shield!

Fig. 33 Table for pin assignment of digital interface RS485

4.5.3 Sensor

The output signal increases, when the plunger is moved into the sensor. If the reverse effective direction is required (i.e. the signal becomes smaller when the plunger is inserted), replace the connections Secondary + and Secondary -.

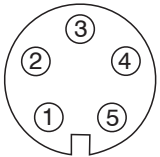
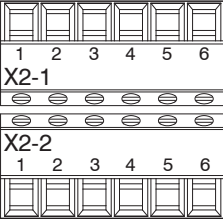
Pin assignment Sensor 1 + 2 (DTA/LVDT)	Variant with cable gland				Connector  5-pin housing socket M9 (Binder, series 712) View on pin side
					
Assignment	Pin X2-x	DTA-x-CA-x DTA-x-CR-x Cable C701-x	DTA-x-CA-x	DTA-xG8-x	5-pin
Shield	1	Shield	-	Shield	Housing
Secondary center tap	2	Gray	Gray	Gray	5
Secondary +	3	White	White	Black	1
Secondary -	4	Brown	Black	White	2
Primary +	5	Green	Green	Blue	3
Primary -	6	Yellow	Yellow	Brown	4

Fig. 34 Table for pin assignment of sensor (DTA/LVDT)

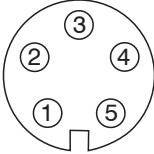
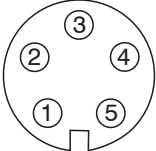
Pin assignment Sensor 1 + 2 (LDR)	Variant with cable gland			Connector
				 <p>5-pin housing socket M9 (Binder, series 712) View on pin side</p>
Assignment	Pin X2-x	LDR-x-CA LVP-25-Z20-x	Cable C7210-x	5-pin
Shield	1	-	-	Housing
Secondary center tap	2	Green	Black	5
Secondary +	3	White	Brown	1
Secondary -	4	Brown	Blue	2
Primary +	5	-	-	3
Primary -	6	-	-	4

Fig. 35 Table for pin assignment of sensor (LDR)

i Cable lengths ≥ 10 m between sensor and controller may impair the technical data, [see 2.3](#).

4.6 Power Supply, Sensor and Signal Output MSC7602

The MSC7602 is designed for multi-channel operation. Therefore, power supply and RS485 must therefore be applied only to one controller and can then be transmitted to the adjacent controller via a DIN rail bus connector on the rear side.

The Sync signal is only available on the DIN rail bus connector and executed in series, i.e., it is not daisy-chained in the bus connector.

All of the connections for the power supply/sensors/signal output are on the controller, see Fig. 36 ff.

Connections:

Screw terminal connection; AWG 16 up to AWG 24; up to AWG 28 with ferrule

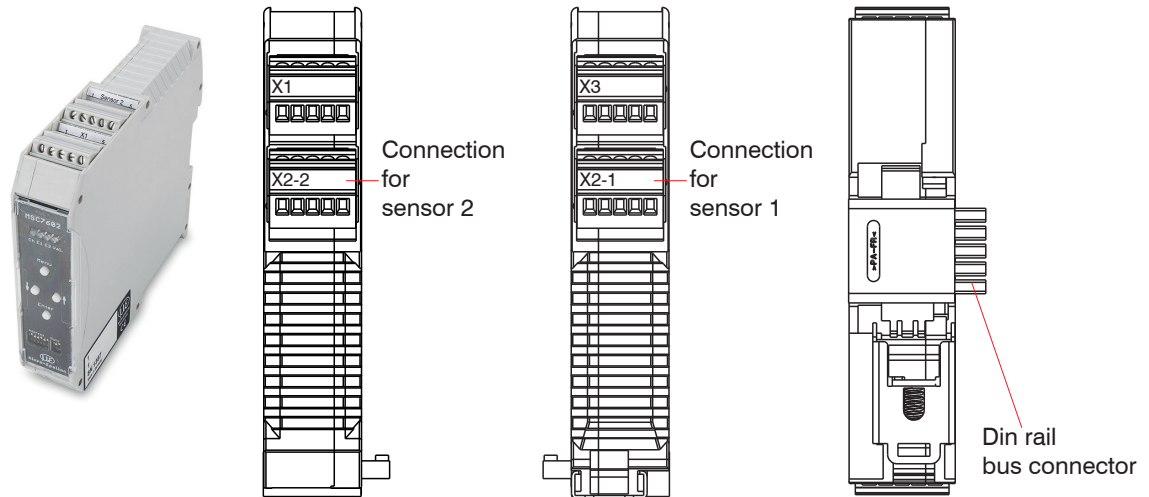


Fig. 36 View MSC7602

Fig. 37 Upper view,
MSC7602

Fig. 38 Lower view,
MSC7602

Fig. 39 View rear side,
MSC7602 inclusive
DIN rail bus connector

4.6.1 Power Supply and Signal

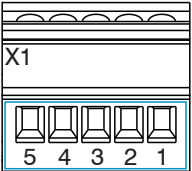
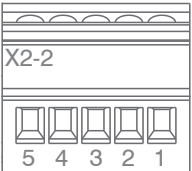
Assignment	Pin X1	Color (cable: PC7400-6/4)	
Supply voltage +24 V	1	White	
GND supply/signal ground	2	Brown	
Output signal 1	3	Yellow	
Output signal 2	4	Green	
Cable shield sensor 2 (direct connection to DIN rail)	5	-	
			

Fig. 40 Table for pin assignment of supply and analog output

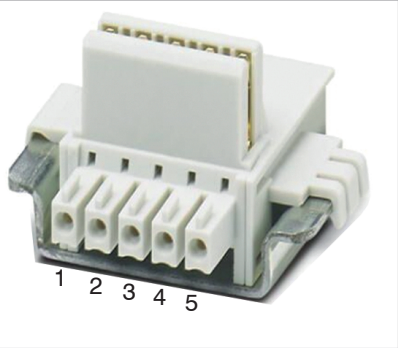
Assignment	Pin	
Supply voltage +24 V	1	
Ground 0 V	2	
RS485 A	3	
RS485 B	4	
Sync-signal	5	
ME22,5 TBUS 1,5/4P1S KMGY (Phoenix: 2201732) Suitable mating plug: MCVR 1.5/5-ST-3.81 (Phoenix: 1827156)		

Fig. 41 Table for pin assignment of DIN rail bus connector

4.6.2 Sensor

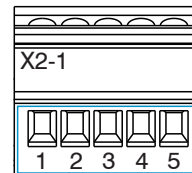
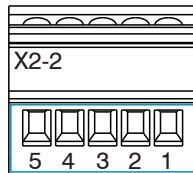
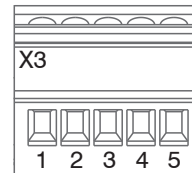
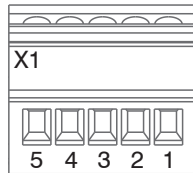


Fig. 42 Terminal block X2-2

Fig. 43 Terminal block X2-1

Assignment	Pin X2-x	DTA-x-CA-x DTA-x-CR-x Cable C701-x	DTA-x-CA-x	DTA-xG8-x
Secondary center tap	1	Gray	Gray	Gray
Secondary +	2	White	White	Black
Secondary -	3	Brown	Black	White
Primary +	4	Green	Green	Blue
Primary -	5	Yellow	Yellow	Brown
Cable shield sensor 1 + 2, see X1 and X3				

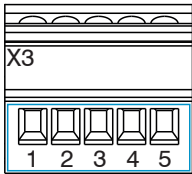
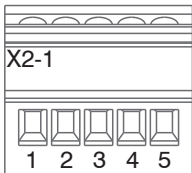
Fig. 44 Table for pin assignment sensor 1 + 2 (DTA/LVDT)

Assignment	Pin X2-x	LDR-x-CA LVP-25-Z20-x	Cable C7210-x
Secondary center tap	1	White	White
Secondary +	2	Brown	Black
Secondary -	3	Green	Green
Primary +	4	Yellow	Yellow
Primary -	5	Gray	Gray
Cable shield sensor 1 + 2, see X1 and X3			

Fig. 45 Table for pin assignment sensor 1 + 2 (LDR)

i Cable lengths ≥ 10 m between sensor and controller may impair the technical data, see 2.3.

4.6.3 Digital Interface

Assignment	Pin X3	Color (IF7001)	
A (RS485)	1	Brown	
B (RS485)	2	White	
-	3	-	
-	4	-	
Cable shield sensor 1 (direct connection to DIN rail)	5	-	

i Do not apply the IF7001 shield!

Fig. 46 Table for pin assignment of digital interface X3

5. Operation

▶ Before starting the measurement or making settings, let the controller with connected sensor warm up for approx. 2 minutes while supply voltage is switched on.

•
i Observe the operating instructions of the sensors used.

•
i If a sensor is replaced, the channel must be re-parameterized and readjusted.

The parameter setup of the controller may either be performed via keys on the controller or via the `sensor-TOOL`, see A 3. The output is then via the analog outputs or the RS485 interface, see A 4 or the `sensorTOOL`.

Only with the induSENSOR DTD

With the induSENSOR DTD, everything is set at the factory. There are no operation elements. Settings can only be made via the `sensorTOOL` program.

5.1 Initial Operation

- ➡ Connect the sensor before starting the controller, [see 4.4.3](#), [see 4.5.3](#), [see 4.6.2](#).
- ➡ Ensure that the wiring of the sensor connections, signal cable and power supply connections are correct before connecting the controller to the power supply and turning it on, [see 4](#).
- ➡ Then switch on the power supply.
- ➡ Set the controller to its basic setting, [see 5.3](#).

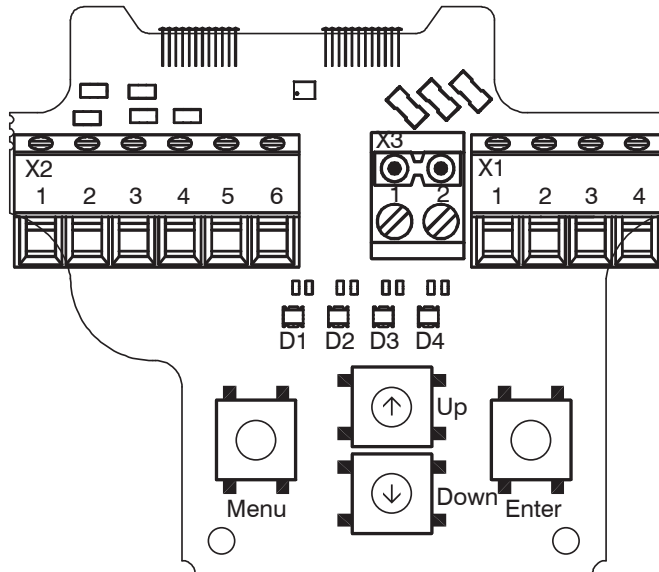


Fig. 47 Controller induSENSOR MSC7401

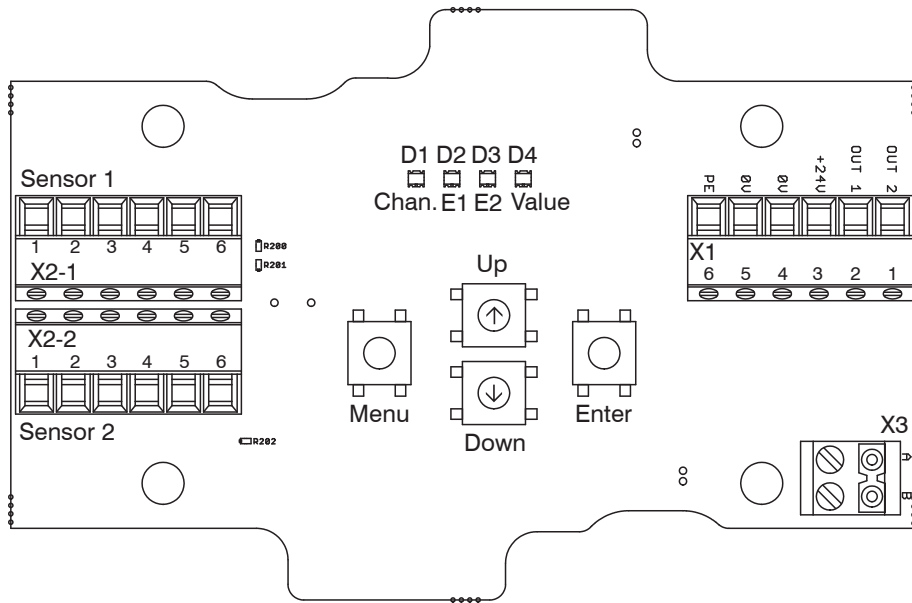


Fig. 48 Controller induSENSOR MSC7802

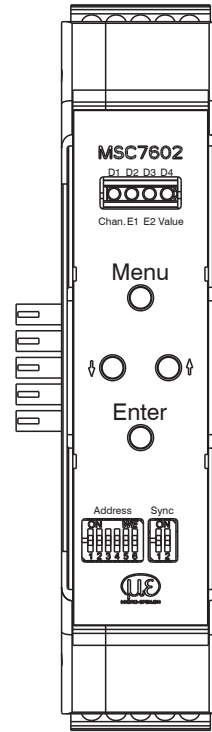


Fig. 49 Controller induSENSOR MSC7602

5.2 Control and Display Elements

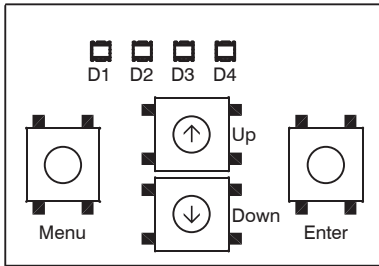


Fig. 50 Control and display elements MSC7401 ¹

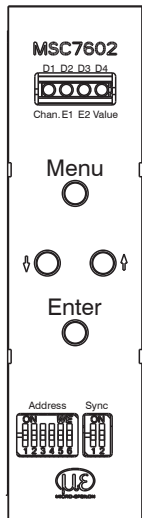


Fig. 51 Control and display elements MSC7602

Button/LED	Function	Description
Menu button	Enter the menu level	-
Enter button	Confirmation	-
↑ and ↓ buttons	Parameter selection	-
LED D1 / Ch	Channel display	The LED Channel indicates the current channel, with ↑ and ↓ the channel can be changed (red and green). Channel 1: green, channel 2: red It flashes in corresponding color, if the channel is not parameterized.
LED D2 / E1	E1 menu level display	The E1 and E2 LEDs show the current position in the menu or the corresponding settings.
LED D3 / E2	E2 menu level display	
LED D4 / Value	Value display	The Value LED indicates the current value of the selected parameters.

1) Description also applies for MSC7802 model.

5.3 Setting

The menu of the MSC7401 / 7802 / 7602 is designed for fast, mainly automated commissioning as well as for individual application-specific settings. It is divided into four function blocks, see Fig. 52. The 4 LEDs show the current position in the menu and the corresponding setting value at any time, see 5.4. Alternatively, the software `sensorTOOL`, can be used, see A 3.

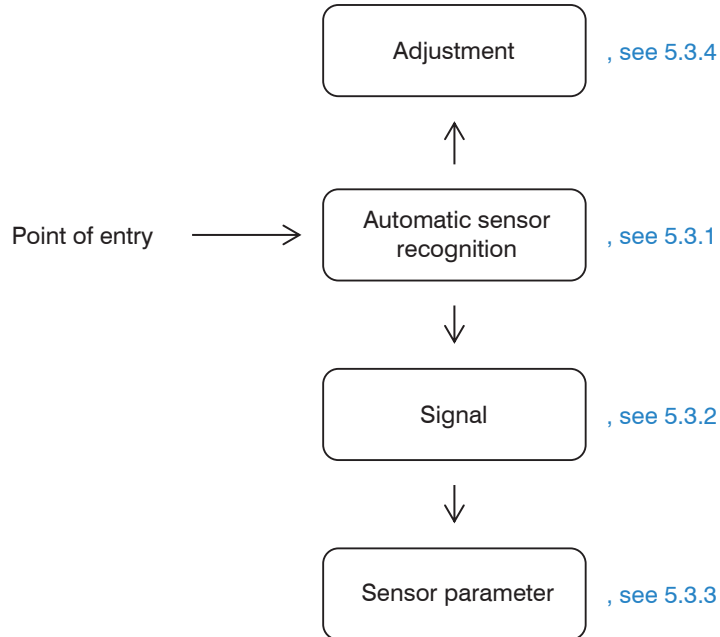


Fig. 52 Menu structure (simple), details, see 5.4

5.3.1 Automatic Sensor Recognition

The first menu item is the automatic sensor recognition.

i Please note that automatic sensor recognition is merely a support feature. Successful recognition cannot be guaranteed on account of tolerances. As such, the recognition result must always be checked.

LED D2 = red

The automatic sensor recognition checks the connected sensor and determines the parameters for the common MICRO-EPSILON sensors:

- Sensor type (half bridge or full bridge (LVDT))
- Supply frequency and
- Excitation voltage

After the automatic sensor recognition has been completed, the LEDs confirm the status.

D3/D4 = green	Sensor recognition successful	After successful recognition, the system is ready for use. The output signal is preset according to the factory setting, as well as a rough adjustment of the measuring signal.
D3/D4 = red	Automatic recognition is not successful	The parameters must now be set manually according to the respective instruction manuals of the sensor used. An automatic jump to the menu item <code>Sensor parameter</code> is done, see 5.3.3.

5.3.2 Signal

LED D2 = orange

This function allows you to adjust the type of output signal, e.g., 2 ... 10 V or 4 ... 20 mA.

Automatic recognition is available. For a load at the output of:

- > 1 kOhm, voltage output 2 ... 10 V is set,
- < 1 kOhm, current output 4 ... 20 mA is set.

5.3.3 Sensor Parameters

LED D2 = red flashing

With this function, you can set the parameters

- sensor type,
- supply frequency and
- excitation voltage

if the automatic recognition is not successful, or for special areas of use other settings may be necessary. These depend on the sensor model used. After manual setting of the sensor parameters, the adjustment of the system, [see 5.3.4](#), is recommended.

Sensor model	Measuring range	Sensor type	Supply frequency	Excitation voltage	
DTA-1x	±1 mm	LVDT	5 kHz	550 mV	
DTA-3x	±3 mm		5 kHz		
DTA-5x	±5 mm		5 kHz		
DTA-10x	±10 mm		2 kHz		
DTA-15x	±15 mm		1 kHz		
DTA-25x	±25 mm		1 kHz		
LDR-10	10 mm	LDR	21 kHz		
LDR-25	25 mm		13 kHz		
LDR-50	50 mm		9 kHz		
LVP-3	3 mm		18 kHz		
LDR-14	With 8 mm drawbar		14 mm		23 kHz
	With 10 mm drawbar				23 kHz
LVP-25	With 8 mm drawbar		25 mm		16 kHz
	With 10 mm drawbar				16 kHz

Fig. 53 Sensor models and sensor parameters

5.3.4 Adjustment

LED D2 = green

At the menu `Settings > Adjustment`, you can use either a two-point adjustment or a Zero-point adjustment. In this menu, the controller can also be reset to the factory settings.

Two-point adjustment	Here you can set any 2 points within the measuring range and the corresponding signal values.
Factory settings	The controller can be reset to the parameters stored by default, see A 2 .
Zero-point adjustment	This is a special case of a two-point adjustment and provides the best performance for the measuring system. The first of the two points is the electrical zero point at which a differential sensor shows the highest stability on principle.

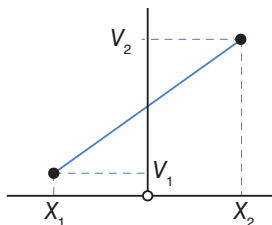


Fig. 54 Graphic Two-point adjustment

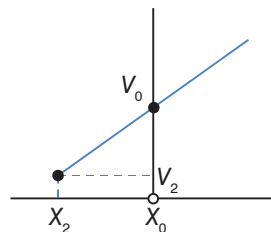


Fig. 55 Graphic Zero-point adjustment

5.4 Menu Structure























































Legend of the menu structure ¹	
	LED orange
	LED orange flashing
	LED green
	LED green flashing
	LED red
	LED red flashing
	LED off
SMR	Start of measuring range
MMR	Mid of measuring range
EMR	End of measuring range

Fig. 56 Legend of the menu structure

1) For pages 51 to 58

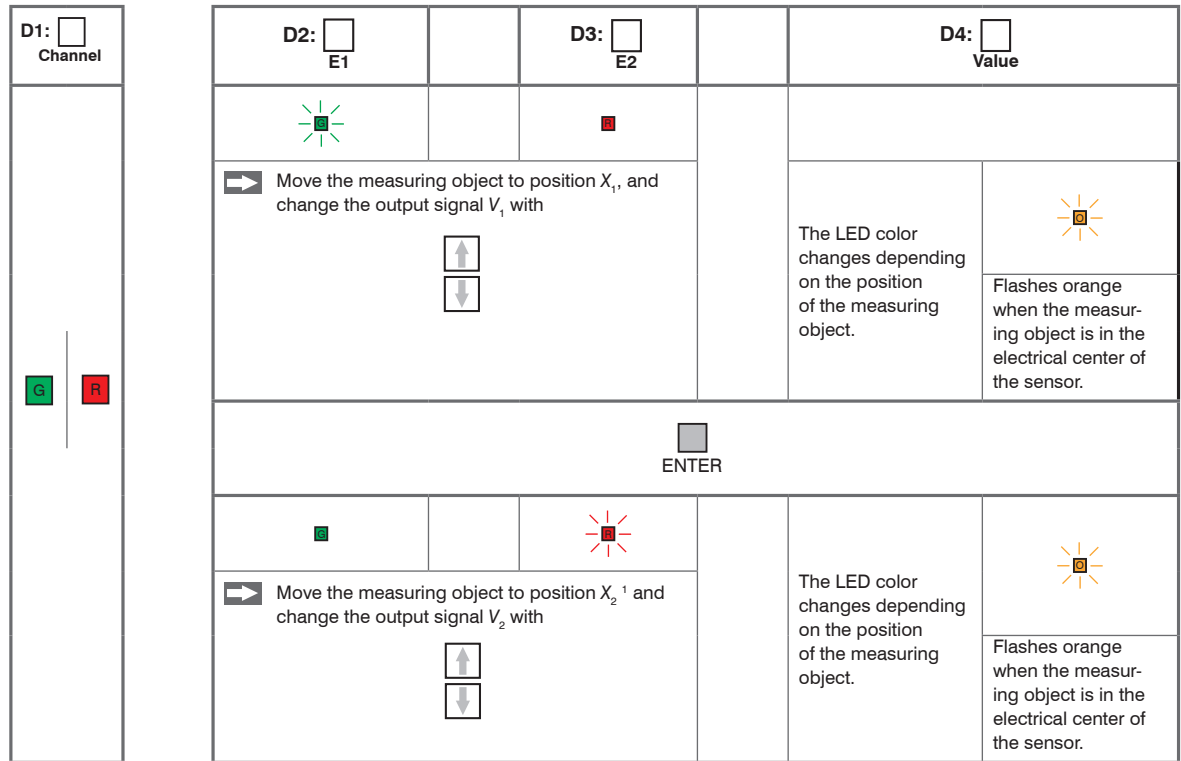
D1: <input type="checkbox"/> Channel	D2: <input type="checkbox"/> E1		D3: <input type="checkbox"/> E2			D4: <input type="checkbox"/> Value		Next menu		
   		Adjustment		 	 Two-point adjustment  Factory settings  Zero-point adjustment		 Go to the adjustment modes two-point adjustment, see Fig. 58 or zero-point adjustment, see Fig. 59 .		 E1 level	
										
		Automatic sensor recognition		 Successful  Failed  Manually set	 Successful  Failed <input type="checkbox"/> Manually set	 E1 level  Sensor parameter Display only				
										
	Signal		 	 Automatic  Voltage  Current		Voltage  	 Voltage  Current  0 ... 10 V  2 ... 10 V  0 ... 5 V  0.5 ... 4.5 V  4 ... 20 mA  0 ... 20 mA  0 ... 10 mA		 E1 level	

Continuation of menu structure of page 51



Fig. 57 Menu structure for the MSC7401 / 7802 / 7602 controllers
induSENSOR DTD / MSC7xxx

5.4.1 Two-point Adjustment











1) Position X_2 must be $> 10\%$ of the measuring range away from X_1 .

Fig. 58 Menu structure for the MSC7401 / 7802 / 7602 controllers, adjustment mode: Two-point adjustment

1) Position X_2 must be $> 10\%$ of the measuring range away from X_1 .

5.4.2 Zero-point Adjustment

<p>D1: <input type="checkbox"/> Channel</p> <p><input type="checkbox"/> G <input type="checkbox"/> R</p>	<p>D2: <input type="checkbox"/> E1</p>		<p>D3: <input type="checkbox"/> E2</p>		<p>D4: <input type="checkbox"/> Value</p>
					<input type="checkbox"/>
	<p>▶ Set the output signal V_0.</p>				<p>LED off</p>
	<p style="text-align: center;"> <input type="button" value="↑"/> <input type="button" value="↓"/> </p>				
	<p style="text-align: center;">6 VDC or 12 mA is preset.</p>				
	<p><input type="button" value="ENTER"/></p>				
				<p>The LED flashes and color changes depending on the output signal (green = too low red = too high).</p>	
<p>▶ Move the measuring object to position X_0 until the output has reached V_0.</p>				<p>Lights orange when the measuring object is in the electrical center of the sensor.</p>	
<p><input type="button" value="ENTER"/></p>					
				<p>The LED color changes depending on the position of the measuring object.</p>	
<p>▶ Move the measuring object to position $X_2$¹ and change the output signal V_2 with</p>				<p>Flashes orange when the measuring object is in the electrical center of the sensor.</p>	
<p style="text-align: center;"> <input type="button" value="↑"/> <input type="button" value="↓"/> </p>					

1) Position X_2 must be > 10 % of the measuring range away from X_1 .

Fig. 59 Menu structure for the MSC 7401 / 7802 / 7602 controllers, adjustment mode: Zero-point search

5.4.3 Example A: Sensor Parameter Adjustment: DTA-5G8, Channel 1

D1	D2	D3	D4
	<input type="checkbox"/>	<input type="checkbox"/>	<input type="checkbox"/>
□ MENU			
		<input type="checkbox"/>	<input type="checkbox"/>
□ ENTER			
□ ENTER			
□ ENTER			
□ ENTER			
			<input type="checkbox"/>

Press the `MENU` button for 3 sec.

After switching on, the sensor is automatically identified. If the recognition was successful, this color code is displayed and you can skip example A.

Output situation: sensor is not automatically recognized.

Press button 2x.

Menu point `Sensor Parameter`, see 5.3.3

Confirm by pressing the `ENTER` button.

Sensor type: LVDT; with the selection can be changed here.

Confirm by pressing the `ENTER` button.

Frequency: 5 KHz; with the selection can be changed here.

Confirm by pressing the `ENTER` button.

Excitation voltage: 550 mV; with the selection can be changed here.

Confirm by pressing the `ENTER` button.

5.4.4 Example B: Signal Output Adjustment: 2 ... 10 V, Channel 1

D1	D2	D3	D4
	<input type="checkbox"/>	<input type="checkbox"/>	<input type="checkbox"/>
■ MENU			
↓			
■ ENTER			
			<input type="checkbox"/>
↓			
			<input type="checkbox"/>
■ ENTER			
■ ENTER			

➡ Press the **MENU** button for 3 seconds, if you are not yet in the menu.

Output situation: The sensor parameters are already set; depending on the approach, LED D4 is green or switched off.

Menu point: *Signal*, see 5.3.2; in delivery state, the electronics works with automatic load recognition; depending on the output load, the LED D4 is red (4 ... 20 mA) or orange (2 ... 10 V). If the automatic settings suits you, you can cancel example B here.

➡ Confirm by pressing the **ENTER** button.

Voltage output

➡ Confirm by pressing the **ENTER** button.

2 ... 10 V; with the selection can be changed here.

➡ Confirm by pressing the **ENTER** button.

Output situation: The sensor parameters are already set; depending on the approach, LED D4 is green or switched off.

5.4.5 Example C: Adjustment via Zero-point Adjustment, Channel 1

D1	D2	D3	D4
	<input type="checkbox"/>	<input type="checkbox"/>	<input type="checkbox"/>
MENU			
↑			
		<input type="checkbox"/>	<input type="checkbox"/>
ENTER			
			<input type="checkbox"/>
↓			
			<input type="checkbox"/>
ENTER			
			<input type="checkbox"/>
↓ ↑			
ENTER			
ENTER			
↓ ↑			
ENTER			

➡ Set the sensor parameters according to example A and connect the output signal according to example B.

➡ Press the **MENU** button for 3 seconds, if you are not yet in the menu.

Output situation: The sensor parameters are already set; depending on the approach, LED D4 is green or switched off.

➡ Go to the menu **Adjustment**, see 5.3.4.

➡ Confirm by pressing the **ENTER** button.

➡ Select **Zero point search**.

➡ Confirm by pressing the **ENTER** button.

➡ Now use the arrow keys to set the voltage in such a way that the measuring device displays 6.00 V (V_0).

➡ Confirm by pressing the **ENTER** button.

➡ Now move the measuring object to the zero point (X_0 , MMR), where the measuring device again displays the above set 6.00 V (V_0).

For better orientation, LED D4 changes the color depending on the plunger position. Near the zero point, LED D4 flashes orange.

➡ Confirm by pressing the **ENTER** button.

➡ Now move the measuring object from X_0 5.000 mm towards the start of the measuring range (X_2) and use the arrow keys to set 2.00 V (V_2).

For better orientation, LED D4 changes the color depending on the plunger position. Near the zero point, LED D4 flashes orange.

➡ Confirm by pressing the **ENTER** button.

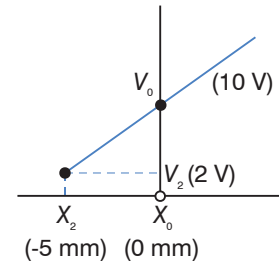


Fig. 60 Example point search

5.4.6 Example D: Adjustment via Two-point Adjustment, Channel 1

D1	D2	D3	D4
	<input type="checkbox"/>	<input type="checkbox"/>	<input type="checkbox"/>
MENU			
↑			
		<input type="checkbox"/>	<input type="checkbox"/>
ENTER			
			<input type="checkbox"/>
↑			
			<input type="checkbox"/>
ENTER			
↓ ↑			
ENTER			
↓ ↑			
ENTER			

➡ Set the sensor parameters according to example A and connect the output signal according to example B.

➡ Press the **MENU** button for 3 seconds, if you are not yet in the menu.

Output situation: The sensor parameters are already set; depending on the approach, LED D4 is green or switched off.

➡ Go to the menu **Adjustment**, see 5.3.4.

➡ Confirm by pressing the **ENTER** button.

➡ Select **two-point adjustment**.

➡ Confirm by pressing the **ENTER** button.

➡ Now move the measuring object to the desired position start of measuring range (X_1).

➡ Use the arrow buttons to set 2.00 V (V_1).

➡ Confirm by pressing the **ENTER** button.

➡ Now move the measuring object 6.000 mm towards the end of the measuring range (X_2).

➡ Use the arrow buttons to set 10.000 V (V_2).

➡ Confirm by pressing the **ENTER** button.

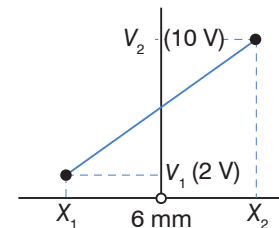


Fig. 61 Example Two-point adjustment

5.5 Multi-Channel Operation

When operating the MSC7401 / MSC7602 / MSC7802 models, multi-channel operation is possible.

i For multi-channel operation, a distance of at least 100 mm between the respective sensors is recommended.

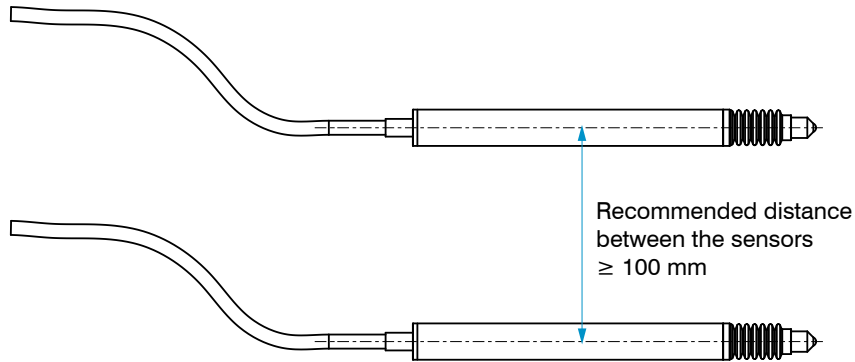


Fig. 62 Multi-channel operation of 2 sensors

5.5.1 Operation on the RS485 Bus with Multiple Channels

The connection to the RS485 bus enables to directly read out the measurement values, [see A 4](#).

The respective addresses can be individually set from 1 ... 126.

NOTICE

Please avoid in each operating mode using the same addresses multiple times on the bus.

> Data collision / System crash

With the MSC7401 and MSC7802 models, the addresses can exclusively be set via software, [see A 3](#). The MSC7602 model in addition enables to set the address via a DIP switch, [see Fig. 63](#).

The MSC7602 and MSC7802 2-channel variants hold a special status.

When the addresses are firmly assigned via DIP switch, [see Fig. 64](#), always both addresses are set, e.g., channel 1 = address 100 → channel 2 = address 99.

However, if the addresses are assigned via the `sensorTOOL`, [see Fig. 64](#), the addresses can be set individually. But channel 1 only allows even address values while channel 2 only allows odd address values. If an entry is incorrect, the addresses are automatically set to the next higher even address or the next lower address.

i Please note that the transmission frequency per channel is reduced as the number of participants on the bus increases, as all channels have to be queried in series. Per channel, the duration of a message (query and response) is approx. 3 ms with 256,000 baud.

When using the `sensorTOOL` program on Windows, a maximum data rate of only 12 ms per message is possible.

The maximum number of participants (incl. master) on a bus line is 64. Depending on the length of the line and environmental conditions, an external terminating resistor may be required.



Fig. 63 DIP switch on the MSC7602 for multi-channel operation

Address		Switch setting						Value binary
Sensor 1	Sensor 2	S1	S2	S3	S4	S5	S6	
126 ^{1 2}	125 ^{1 2}	OFF	OFF	OFF	OFF	OFF	OFF	000000
2	1	ON	OFF	OFF	OFF	OFF	OFF	000001
4	3	OFF	ON	OFF	OFF	OFF	OFF	000010
6	5	ON	ON	OFF	OFF	OFF	OFF	000011
8	7	OFF	OFF	ON	OFF	OFF	OFF	000100
...
118	117	ON	ON	OFF	ON	ON	ON	111011
120	119	OFF	OFF	ON	ON	ON	ON	111100
122	121	ON	OFF	ON	ON	ON	ON	111101
124	123	OFF	ON	ON	ON	ON	ON	111110
126	125	ON	ON	ON	ON	ON	ON	111111

Fig. 64 Address assignment on the induSENSOR MSC7602

1) Factory settings

2) The address can be set using the `sensorTOOL`, see A 3.

i Please note that the bus master requires an individual address. With the bus master from MICRO-EPSILON MESSTECHNIK (e.g., `sensorTOOL`, IF1032 or IF2030), this address is always 1.

This is how max. 62 single-channel or 31 dual-channel controllers can be operated on the RS485 bus.

5.5.2 Synchronization and Installation of Multiple Channels

MSC7602 model

If the minimum distance of ≥ 100 mm, [see 5.3](#), is impossible, the MSC7602 model in addition offers the possibility to synchronize the supply frequency of the sensors. This significantly reduces or eliminates cross-talking between the channels, which strongly depends on the sensor used and the distance or arrangement to one another.

The following prerequisites/restrictions apply for sync operation:

- All synchronized sensors must be operable with the supply frequency of the master sensor, [see 5.3.3](#).
- In sync mode, no automatic sensor recognition is possible with the slave.
- In sync mode, the slave channel must be set to the frequency of the master.
- The synchronization settings are not possible via the `sensorTOOL`, [see A 3](#).
- Synchronization is only possible with a frequency response set to ≥ 50 Hz.

The respective synchronization modes can be set via DIP switches:


	Switch setting		Operation	
	S1	S2	Sensor 1	Sensor 2
	off ¹	off ¹	independent	independent
	off	on	Master	Slave
	on	off	Slave	independent
	on	on	Slave	Slave
	on	on	Slave	Slave

Fig. 65 DIP switch on the induSENSOR MSC7602 for synchronization

1) Factory settings

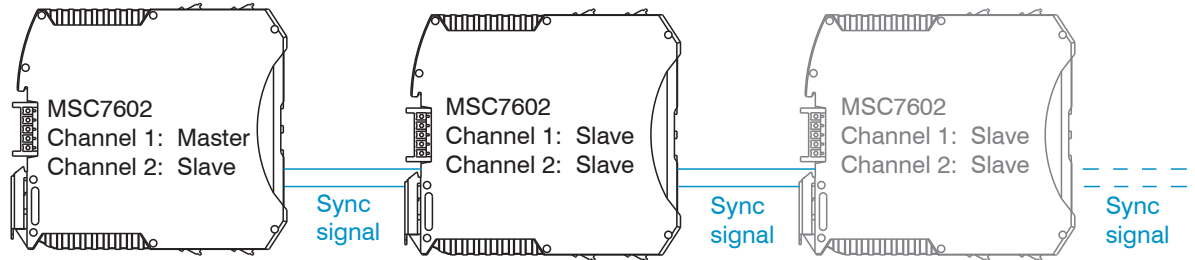


Fig. 66 Example of synchronization induSENSOR MSC7602

MSC7802 model

The MSC7802 offers restricted synchronization possibilities. If these are necessary in the application, please contact Micro-Epsilon Messtechnik GmbH & Co. KG.

6. Service, Repair

If the controller or the sensor are defective, please send in the affected parts for repair or replacement.

If the cause of a fault cannot be clearly identified, please send the entire measuring system to:

MICRO-EPSILON MESSTECHNIK
GmbH & Co. KG

Koenigbacher Str. 15
94496 Ortenburg / Germany

Tel. +49 (0) 8542/ 168-0
Fax +49 (0) 8542/ 168-90
info@micro-epsilon.com
www.micro-epsilon.com

7. Disclaimer

All components of the device have been checked and tested for functionality in the factory. However, should any defects occur despite careful quality control, these shall be reported immediately to MICRO-EPSILON or to your distributor / retailer.

MICRO-EPSILON undertakes no liability whatsoever for damage, loss or costs caused by or related in any way to the product, in particular consequential damage, e.g., due to

- non-observance of these instructions/this manual,
- improper use or improper handling (in particular due to improper installation, commissioning, operation and maintenance) of the product,
- repairs or modifications by third parties,
- the use of force or other handling by unqualified persons.

This limitation of liability also applies to defects resulting from normal wear and tear (e.g., to wearing parts) and in the event of non-compliance with the specified maintenance intervals (if applicable).

MICRO-EPSILON is exclusively responsible for repairs. It is not permitted to make unauthorized structural and / or technical modifications or alterations to the product. In the interest of further development, MICRO-EPSILON reserves the right to modify the design.

In addition, the General Terms of Business of MICRO-EPSILON shall apply, which can be accessed under Legal details | Micro-Epsilon <https://www.micro-epsilon.com/impressum/>

For translations into other languages, the German version shall prevail.

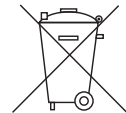
8. Decommissioning, Disposal

In order to avoid the release of environmentally harmful substances and to ensure the reuse of valuable raw materials, we draw your attention to the following regulations and obligations:

- Remove all cables from the sensor and/or controller.
- Dispose of the sensor and/or the controller, its components and accessories, as well as the packaging materials in compliance with the applicable country-specific waste treatment and disposal regulations of the region of use.
- You are obliged to comply with all relevant national laws and regulations.

For Germany / the EU, the following (disposal) instructions apply in particular:

- Waste equipment marked with a crossed garbage can must not be disposed of with normal industrial waste (e.g. residual waste can or the yellow recycling bin) and must be disposed of separately. This avoids hazards to the environment due to incorrect disposal and ensures proper recycling of the old appliances.






- A list of national laws and contacts in the EU member states can be found at https://ec.europa.eu/environment/topics/waste-and-recycling/waste-electrical-and-electronic-equipment-weee_en.



Here you can inform yourself about the respective national collection and return points.

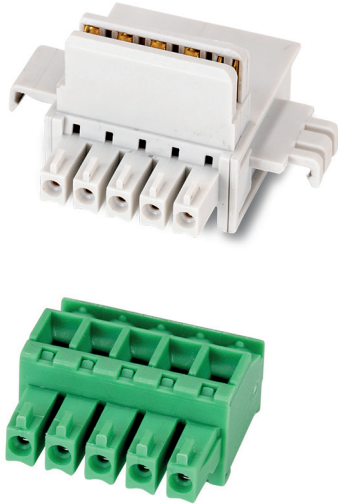
- Old devices can also be returned for disposal to MICRO-EPSILON at the address given in the imprint at <https://www.micro-epsilon.de/impressum/>.
- We would like to point out that you are responsible for deleting the measurement-specific and personal data on the old devices to be disposed of.
- Under the registration number WEEE-Reg.-Nr. DE28605721, we are registered at the foundation Elektro-Altgeräte Register, Nordostpark 72, 90411 Nuremberg, as a manufacturer of electrical and/or electronic equipment.

Appendix

A 1 Optional Accessories

Designation	Photo	Description
PC7400-6/4		Power and output cable; length: 6 m, 4-core, open ends with ferrules, shielded, OD: 5.6 mm
PC5/5-IWT		Power and output cable; connector M12x1, 5 pin, A-coding, length: 5 m, 5-core, open ends, OD: 5.6 mm, IP 67
IF7001		Single-channel USB/RS485 converter for MSC7xxx
<p>You will find further information on IF7001 under: https://www.micro-epsilon.com/download/manuals/ass--IF-7001--de-en.pdf#zoom=Fit</p>		

Description	Photo	Description
IF2030/PNET		<p>Interface component to connect Micro-Epsilon sensors to PROFINET via RS422/RS485 interface, single-channel system with DIN-rail housing; software integration into PLC with GSDML file, certified according to PNIO V2.33</p>
IF2030/ENETIP		<p>Interface module for connecting Micro Epsilon sensors with RS422/RS485 interface to Ethernet/IP 1-channel system with DIN rail housing; Software integration into the PLC with EDS file; Certified according to Ethernet/IP CT16</p>
IF1032/ETH		<p>Multi-channel analog/Ethernet-EtherCAT converter - three analog inputs - one RS485 (single channel) in addition with trigger input</p>

Description	Photo	Description
MSC7602 connector kit		<p>3 x DIN rail bus connector; ME22,5 TBUS 1,5/4P1S KMGY connector (Phoenix: 2201732)</p> <p>1x suitable mate plug for DIN rail mounting: MCVR 1.5/5- ST-3.81 (Phoenix: 1827156)</p>

A 2 Factory Settings

The controller is assigned with the following parameters by default:

- Frequency response: 50 Hz, only adjustable via `sensorTOOL` software, [see A 3](#).
- Language: German
- Automatic recognition of customer signals
- Automatic sensor recognition

Upon successful recognition:


- Start of measuring range (plunger pulled-out): ~ 2 V or 4 mA
- Mid of measuring range (electric zero): ~ 6 V or 12 mA

A 3 Software

`sensorTOOL` gives you a documented software that can be used for setting the sensors, for demonstration purposes or for quick visualization of the measurement data.

You can find it online at <https://www.micro-epsilon.de/download/software/sensorTOOL.exe>.

A 3.1 Controller Search

- ➡ Connect the controller to a free USB port of your PC (e.g. via the IF7001) and connect the power supply.
- ➡ Start the `sensorTOOL` program.
- ➡ In the drop-down-menu, set the sensor group to `induSENSOR` and the sensor type to `induSENSOR MSC7xxx`.
- ➡ Click on the button  with the magnifying glass icon.

All available controllers/channels will now be displayed in the Search Results(x) overview.

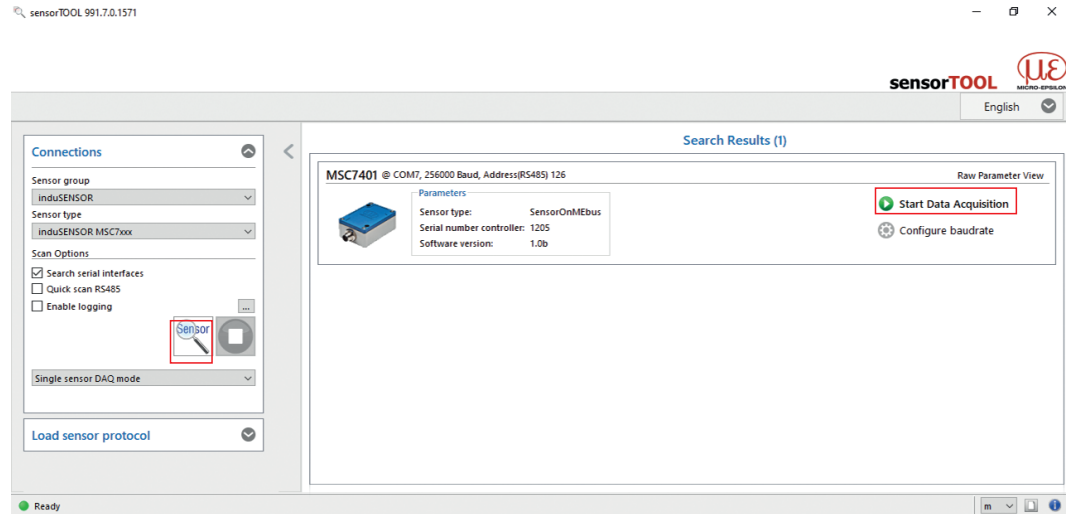


Fig. 67 First interactive site after calling the `sensorTOOL`

A 3.2 Configure Baudrate

➡ Click on the **Configure baud rate**, see Fig. 67, button to apply the basic settings for the serial interface, see Fig. 68, click on **Start Data Acquisition** or on the controller icon, see Fig. 67, to apply other settings and start the data acquisition, see A 3.4.

Fig. 68 Window *Change serial configuration* - *sensorTOOL*

•
i Set the baud rate to 256,000.

A sensor address can be assigned for the sensor.

•
i Please observe the DIP settings of MSC7602, see Fig. 64.

A 3.3 Menu Settings

A 3.3.1 General

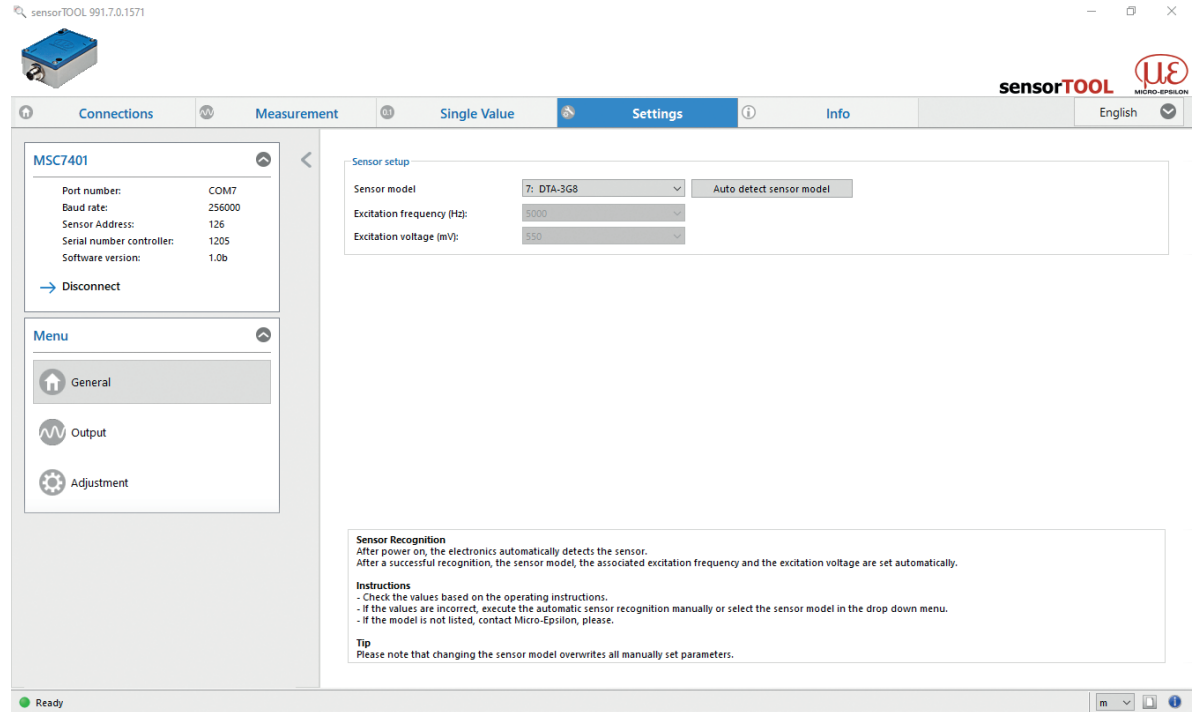


Fig. 69 View Settings - General

Sensor setup	Sensor model	1 - 6: DTA-xD oder 7 - 10: DTA-xG8 127: user defined DTA 129 - 131, 133: LDR-x 132: LVP-25 255: user defined LDR 0: unknown sensor	
		Automatic recognition of sensor model	
	Excitation frequency (Hz)	1000 / 2000 / 5000 / 8000 / 9000 / 10000 / 12000 / 13000 / 16000 / 18000 / 21000 / 23000 / 25000	Only with user-defined sensor setting
Excitation voltage (mV)	550 / 350 / 150 / 75		

Three options for sensor configuration:

- Automatic sensor recognition, [see 5.3.1](#)
- Model setting
- User-specific sensor setting

i Please note that automatic sensor recognition is merely a support feature. Successful recognition cannot be guaranteed on account of tolerances. As such, the recognition result must always be checked.

Sensor recognition

After switching on, the controller automatically identifies the sensor.

After successful recognition, the sensor model, the associated excitation frequency and the excitation voltage are automatically set.

➡ Check the values based on the operating instructions, [see 5.3.3](#).

If the values are not correct, carry out the automatic sensor recognition manually or select the sensor model in the drop down menu.

i If the sensor model is not listed in the drop down menu, please contact Micro-Epsilon.
Please note that changing the sensor model overwrites all manually set parameters.

Fields with gray background require a selection.

Fields with dark border require entry of a value.

A 3.3.2 Output

sensorTOOL 991.7.0.1571

MSC7401

Port number: COM7
Baud rate: 25000
Sensor Address: 126
Serial number controller: 1205
Software version: 1.0b

Disconnect

Menu

- General
- Output
- Adjustment

Connections Measurement Single Value **Settings** Info

sensorTOOL

English

Analog output

Output range: 2.0 V .. 10.0 V

Frequency response: 50 Hz

0.52V

After power on, the electronics automatically analyzes the output load.
Depending on the result, 4...20mA or 2...10V are automatically selected.
Alternately you may set the output range manually via the drop-down menu.

Frequency response:
In order to achieve an optimal resolution, it is recommended to reduce the frequency response as much as possible.
Please note that a reduced frequency response also involves reduced measurement dynamics.

Ready

Fig. 70 View Settings - Output

Analog output

Output range: 2.0 V .. 10.0 V

Frequency response: 50 Hz

Fig. 71 Settings - Analog output

Analog output	Output range	<i>Automatic / 0.0 V .. 10.0 V / 2.0 V .. 10.0 V / 0.0 V .. 5.0 V / 0.5 V .. 4.5 V / 4.0 mA .. 20.0 mA / 0.0 mA .. 20.0 mA / 0.0 mA .. 10.0 mA</i>	Description, see 5.3.2
	Frequency response	<i>20 Hz / 50 Hz / 100 Hz / 200 Hz / 300 Hz</i>	-

If `automatic` is selected under `Analog output > Output range`, the output load is analyzed automatically after the electronics are switched on.

Depending on the result, 4 ... 20 mA or 2 ... 10 V is output.

Alternatively you may set the output range manually via the drop down menu, [see Fig. 71](#).

Frequency response:

In order to achieve an optimal resolution, it is recommended to reduce the frequency response as much as possible.

i Please note that a reduced frequency response also involves a reduced measurement dynamics.

Fields with gray background require a selection.

Fields with dark border require entry of a value.

A 3.3.3 Adjustment

There are two possible settings in the Adjustment menu:


- Two-point adjustment
- Zero-point adjustment

A 3.3.3.1 Two-point Adjustment

The screenshot shows the sensorTOOL software interface for an MSC7401 sensor. The main window is titled "Two-point adjustment" and contains the following elements:

- Device Information (Left Sidebar):**
 - Part number: COM7
 - Board rate: 230000
 - Sensor Address: 126
 - Serial number controller: 1205
 - Software version: 1.0b
 - Buttons: Disconnect
- Menu (Left Sidebar):**
 - General
 - Output
 - Adjustment (Selected)
 - Two-point
 - Zero-point
- Two-point adjustment (Main Window):**
 - Start:** A green play button icon.
 - Step 1: Move target to X1:**
 - Analog output at X1 (V or mA): 2,000
 - Use mm scaling. Set X1 to (mm): 3,000
 - Target position (Hz): n/a
 - Accept X1 button
 - Step 2: Move target to X2:**
 - Output: Absolute position X2
 - Value: 10,000
 - Value: -3,000
 - Target position (Hz): n/a
 - Accept X2 button
 - Two-point adjustment diagram:** A graph showing a linear relationship between position (mm) and output (V). The x-axis ranges from 0.00 mm to 3.00 mm, and the y-axis ranges from 2V to 10V. A blue line starts at (0.00, 2V) and ends at (3.00, 10V). The area under the line is divided into green and orange regions.
 - Instructions:**
 - Before sensor adjustment, please ensure that the basic setup was executed (sensor configuration, output signal) and that the target can be positioned accordingly.
 - Start the sensor adjustment with the start icon.
 - Next move the target to the desired position X1.
 - Enter the corresponding output value. Click "Accept X1".
 - Repeat this procedure for the second position X2.
 - Tip:** Optionally, you may enter the associated millimeter values which can be found under measurement and the designation custom.

Fig. 72 View 1 Two-point adjustment

- ➡ Please make sure before the adjustment that the basic settings were carried out (sensor configuration, output signal) and that the target can be positioned accordingly.
- ➡ Start the sensor adjustment via the  button.

- ➡ Then move the target to the desired position X_1 .
- ➡ Enter the corresponding output value. Click **Accept** X_1 .

The screenshot shows the SensorTool 1.2.0 interface for device MSC7401. The 'Settings' tab is selected, showing the 'Two-point adjustment' section. The interface is divided into several panels:

- Left Panel (Menu):** Contains 'General', 'Output', and 'Adjustment' sections. The 'Adjustment' section has buttons for 'Two-point' and 'Zero-point'.
- Top Left Panel (Device Info):** Lists device details: Port number: COM7, Baud rate: 256000, Sensor Address: 126, Serial number controller: 1205, Software version: 1.0b. A 'Disconnect' button is below.
- Main Settings Panel:**
 - Two-point adjustment:** Includes an 'Abort' button (green play icon).
 - Step 1: Move target to X1:** 'Analog output at X1 (V or mA):' is set to 0.000. A checkbox 'Use mm scaling. Set X1 to (mm):' is checked. 'Target position (%):' is -65.89. An 'Accept X1' button is present.
 - Step 2: Move target to X2:** 'Output' is set to 4.000. 'Absolute position X2' is set to 65.66. An 'Accept X2' button is present.
- Two-point adjustment diagram:** A graph showing a linear relationship between position (%) and output voltage (V). The y-axis ranges from 2V to 10V. The x-axis ranges from -100% to +100%. A blue line passes through the points (-100%, 2V) and (+100%, 10V). A specific point is marked at 65.66% on the x-axis and 4.000V on the y-axis.

Fig. 73 View 2 Two-point adjustment

- ➡ Repeat this process for the step second position X_2 .

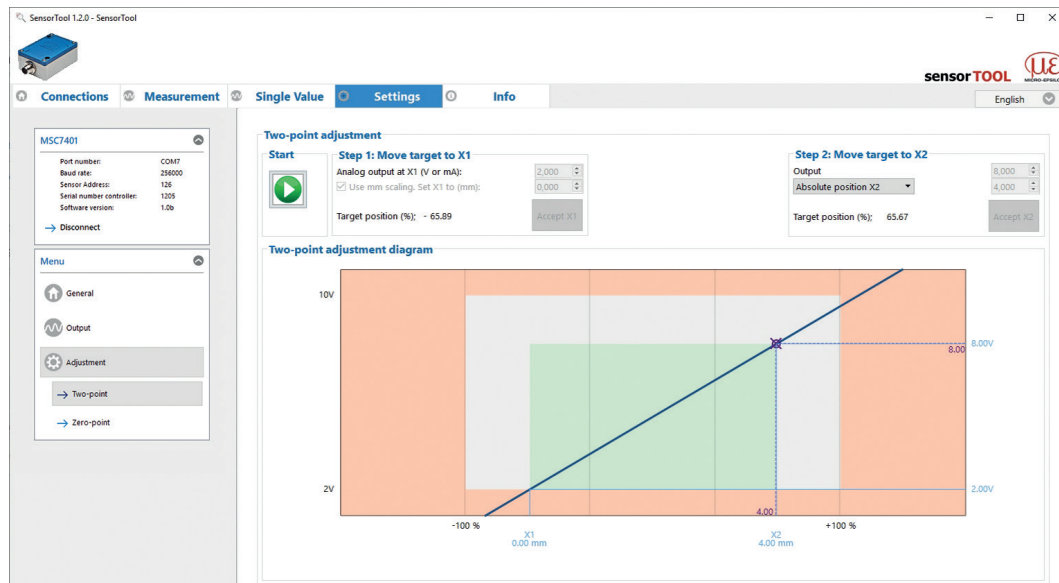


Fig. 74 View 3 Two-point adjustment

i Optionally, you can enter the associated millimeter values which can be found under Measurement and the additional designation Custom ¹, see Fig. 78.

1) Sensor designation, e.g., DTA-3G8 Custom

The chart is divided into 3 areas:

Green	Taught-in range, limited by X_1 , X_2 and the associated output signals.
White	Usable range outside the taught-in range
Red	Unavailable range

A 3.3.3.2 Zero-point Adjustment

Connections **Measurement** **Single Value** **Settings** **Info**

MSC7401

Port number: COM7
 Baud rate: 256000
 Sensor address: 126
 Serial number controller: 1205
 Software version: 1.06

→ Disconnect

Menu

General
 Output
 Adjustment
 → Two-point
 → Zero-point

Zero point

Start

Step 1: Find zero point X0 (0%)

Analog output at X0 (V or mA): 6,000
 Use mm scaling: Set X0 to (mm): 0,000
 Target position (%): 0,00

Accept X0

Step 2: Move sensor to reference point X2

Output: Absolute position X2
 Analog output at X2 (V or mA): -3,000
 Target position (%): 65,67

Accept X2

Zero-point adjustment diagram

10V
 2V
 10.00V
 2.00V
 -100 %
 3.00 mm
 0.00 %
 +100 %
 -3.00 mm

Instructions

- Before performing the adjustment, please ensure that the basic set-up was executed (sensor configuration, output range) and that the target can be positioned accordingly.
- Start the sensor adjustment with the start icon.
- Next move the target to the zero point X0 (target position = 0%).
- Enter the desired sensor output value for the mid of the measuring range and apply it by using the button "Accept X0".
- Move the target to the adjustment point X2 (must be within the measuring range). Enter the desired output value and apply it (button "Accept X2").

Ready

Fig. 75 View 1 Zero-point adjustment

- ➡ Please make sure before the adjustment that the basic settings were carried out (sensor configuration, output signal) and that the target can be positioned accordingly.
- ➡ Start the sensor adjustment via the `Start` button.
- ➡ Then move the target to the zero point X_0 (target position = 0 %)
- ➡ Enter the desired output value for the midrange and accept it by clicking the button `Accept X0`.

The screenshot shows the SensorTool 1.2.0 software interface. The main window is titled "SensorTool 1.2.0 - SensorTool". The interface is divided into several sections:

- Connections:** Shows device information for MSC7401:

Port number:	COM7
Baud rate:	256000
Sensor Address:	126
Serial number controller:	1205
Software version:	1.06
- Menu:** Includes options for General, Output, and Adjustment. The Adjustment menu is expanded, showing "Two-point" and "Zero-point" options.
- Zero point section:**
 - Start:** A green play button is visible.
 - Step 1: Find zero point X0 (0%):** Includes a checkbox for "Use mm scaling. Set X0 to (mm):", a "Target position (%): 0.01" field, and an "Accept X0" button.
 - Step 2: Move sensor to reference point X2:** Includes an "Output" dropdown menu set to "Absolute position X2", a "2,000" field, a "-3,000" field, a "Target position (%): - 97.97" field, and an "Accept X2" button.
- Zero-point adjustment diagram:** A graph showing a linear relationship between position and output. The y-axis ranges from 2V to 10V. The x-axis ranges from -100% (3.00 mm) to +100% (-3.00 mm). A red vertical bar indicates the current target position at 0.01%.

Fig. 76 View 2 Zero-point adjustment

- ➡ Now move the target inside the midrange to point X_2 .
- ➡ Also enter the desired output value there and accept it by pressing the button `Accept X2`.

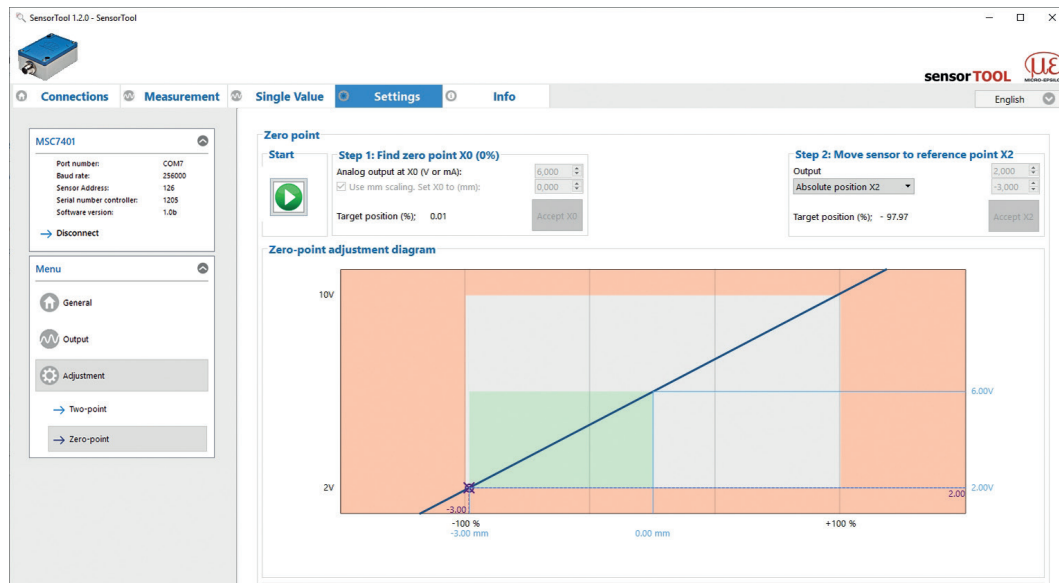


Fig. 77 View 3 Zero-point adjustment

The entire measuring range is now symmetrically arranged around the zero point.

i Optionally, you can enter the associated millimeter values which can be found under **Measurement** and the additional designation **Custom**¹.

The chart is divided into 3 areas:

Green	Taught-in range, limited by X_0 , X_2 and the associated output signals.
White	Usable range outside the taught-in range
Red	Unavailable range

1) Sensor designation, e.g., DTA-3G8 Custom

A 3.4 Measurement Menu

To check your measurements, a simple data acquisition is available.

▶ Apply your desired settings before initial operation, see A 3.3.

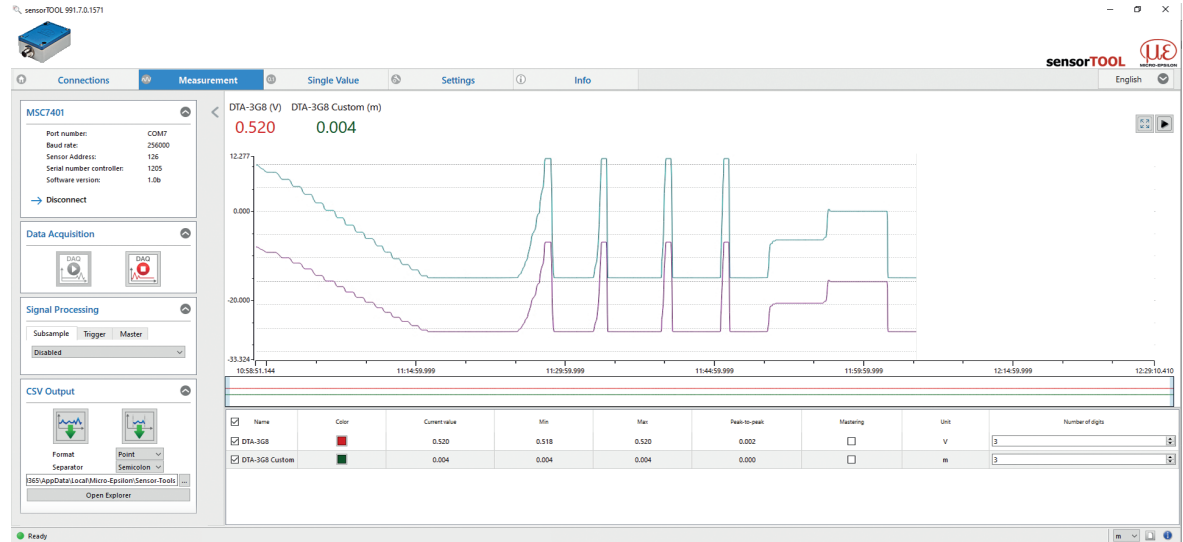


Fig. 78 View Measurement menu

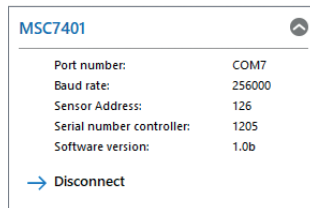




Fig. 79 View Disconnect

By clicking the **Disconnect** button you return to the controller search, see Fig. 67.

	▶ Click the <code>Reset Scale</code> button to reset the Y-scale to initial settings (e.g. after zooming).
	▶ Click the <code>Jump to Head</code> button to display the current signal course.

A 3.4.1 Data Acquisition

▶ Start the data acquisition by clicking the `Start` button, see Fig. 80.

The acquisition is completely restarted and the record stopped before is deleted.

▶ Stop the data acquisition by clicking the `Stop` button, see Fig. 81.

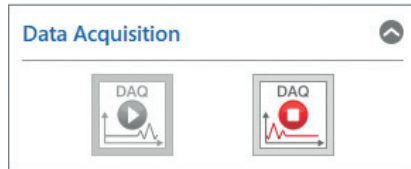


Fig. 80 Start

Fig. 81 Stop

A 3.4.2 Signal Processing

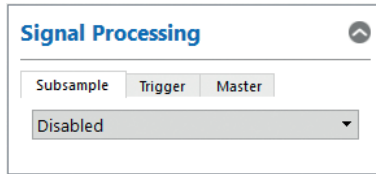


Fig. 82 Signal processing

You can select the following options for signal processing:

Measurement	Signal processing	Subsample	Disabled	Deactivated; basic settings
			Sample-based	Number of samples is adjustable, every xth measurement is recorded.
			Time-based	Time-based; time can be set in milliseconds ¹
		Trigger	Disabled	Deactivated; basic settings
			Continuous	Manual trigger
			One-shot (sample-based)	Sample can be set; records the signal course according to the set samples; the more samples, the longer the course
			One-shot (time-based)	Milliseconds can be set; records the signal course according to the time set
		Master	Master now	Sets the master, see Fig. 84.
			Reset	Resets the master

Fields with gray background require a selection.

Fields with dark border require entry of a value.

1) For example every 5000 ms: The signal course displayed is updated after this period has elapsed.

A 3.4.3 CSV Output

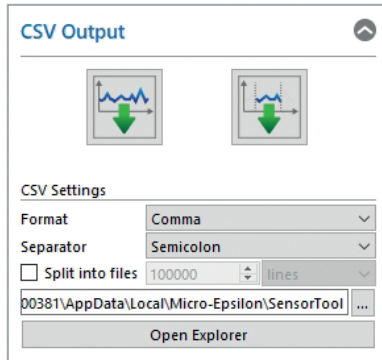


Fig. 83 CSV output

	➡ Click this button to start acquiring the measurement data.
	➡ Click this button to save the currently selected measurement value.

Measurement	CSV output	<i>Format</i>	<i>Point / Comma</i>
		<i>Separator</i>	<i>Comma / Semicolon / Tabulator</i>

Fields with gray background require a selection.

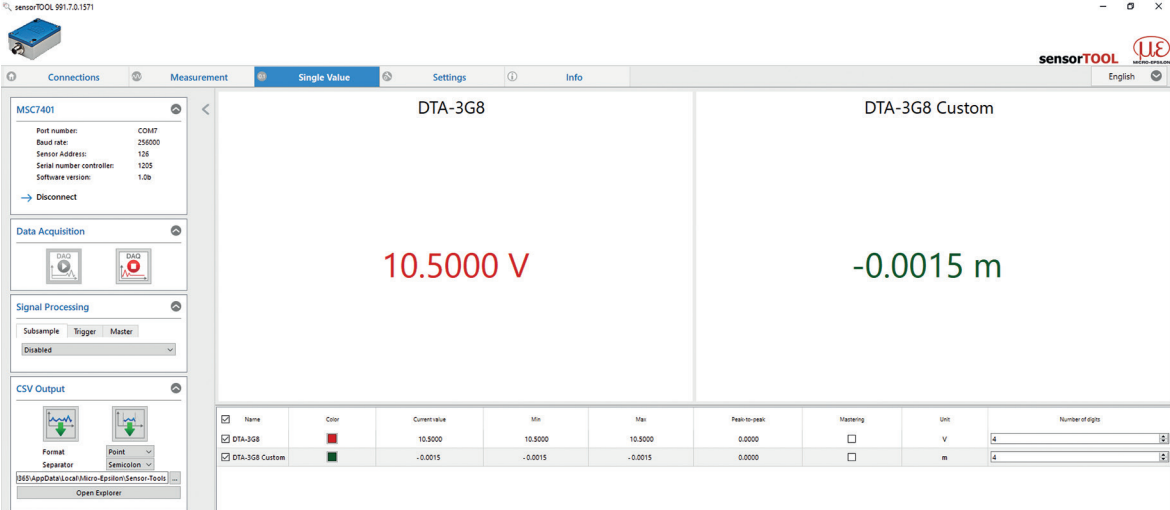
Fields with dark border require entry of a value.

A 3.4.4 Description Data Acquisition Table

Name	Show or hide signal curves of the sensors used.
Color	Change the color settings of the single signal courses.
Mastering	By activating the <code>Mastering</code> checkbox you can manually enter the master value. Master now in the <code>Measurement > Signal Processing</code> menu in the <code>Master</code> tab menu sets the master value, see Fig. 82 .
Unit	<i>Selection of the output to be displayed. The outputs are set before in the <code>Settings</code> menu under <code>Output / Output range and Adjustment</code>.</i>
Number of digits	0 - 12

Fig. 84 Description data acquisition table

A 3.5 Single Value Menu



The screenshot shows the 'Single Value' menu in the sensorTOOL software. The interface is divided into several sections:

- Connections:** Shows port information for MSC7401, including Port number (COM7), Baud rate (250000), Sensor Address (126), Serial number controller (1205), and Software version (1.06). A 'Disconnect' button is visible.
- Data Acquisition:** Contains two icons for data acquisition (DAQ).
- Signal Processing:** Includes a dropdown menu for 'Subsample' (set to 'Disabled') and buttons for 'Trigger' and 'Master'.
- CSV Output:** Features two icons for CSV output, a 'Format' dropdown (set to 'Point'), a 'Separator' dropdown (set to 'Semicolon'), and an 'Open Explorer' button.
- Main Display:** Shows two measurement channels:
 - DTA-3G8:** Displays a current value of 10.5000 V in red text.
 - DTA-3G8 Custom:** Displays a current value of -0.0015 m in green text.
- Table:** A table at the bottom lists the measurement channels and their parameters:

<input checked="" type="checkbox"/>	Name	Color	Current value	Min	Max	Peak-to-peak	Warning	Unit	Number of digits
<input checked="" type="checkbox"/>	DTA-3G8	■	10.5000	10.5000	10.5000	0.0000	<input type="checkbox"/>	V	5
<input checked="" type="checkbox"/>	DTA-3G8 Custom	■	-0.0015	-0.0015	-0.0015	0.0000	<input type="checkbox"/>	m	5

Fig. 85 Single value menu

The following settings have an effect on this display:

- Output: Analog output, [see A 3.3.2](#).
- Adjustment: Two-point adjustment, [see A 3.3.3.1](#) and zero point, [see A 3.3.3.2](#)

A 3.6 Info Menu

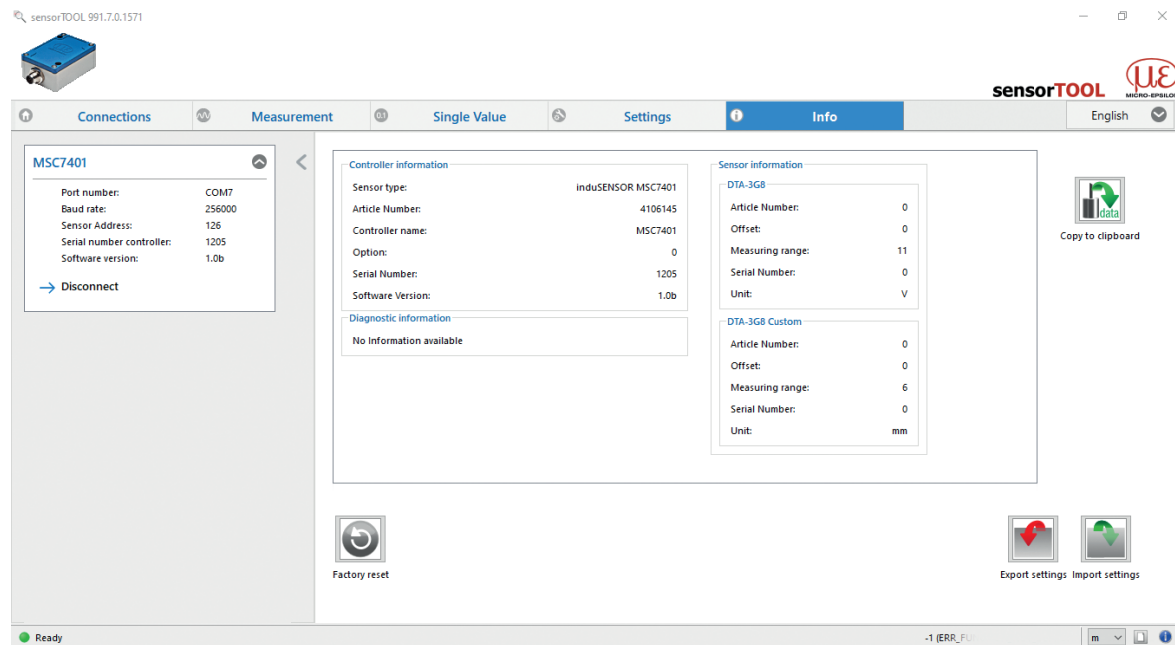


Fig. 86 View Info

This window provides the current overview of the controller information, sensor information, diagnostic information and the currently connected sensor.

When you click the `Disconnect` button, the menu jumps back to the `sensorTOOL` start page, see Fig. 67.



Clicking the `Copy to clipboard` button copies the information and settings for the selected controller to the clipboard.



By pressing the `Factory reset` button, you can restore the factory settings.



`Export settings` opens the explorer to store the setting values in a default file `*.csv` on the PC.



`Import settings` opens the explorer to import the setting values from a default file `*.csv` on the PC.

A 3.7 Multi-Sensor DAQ Mode

The `sensorTOOL` also offers the possibility to output the data from several channels of the induSENSOR DTD / MSC7xxx series.

- i** Please note that the RS485 interface is a serial bus.
Even if the measured values are output simultaneously in `sensorTOOL`, they are recorded with a time delay.

To output the data of several bus participants into one graph, please proceed as follows:

- ➔ Search for the controller via the `sensorTOOL` program, see A 3.1.

- i** Please note that the checkbox `Quick scan RS485` must be deactivated, see Fig. 87, to find multiple channels.

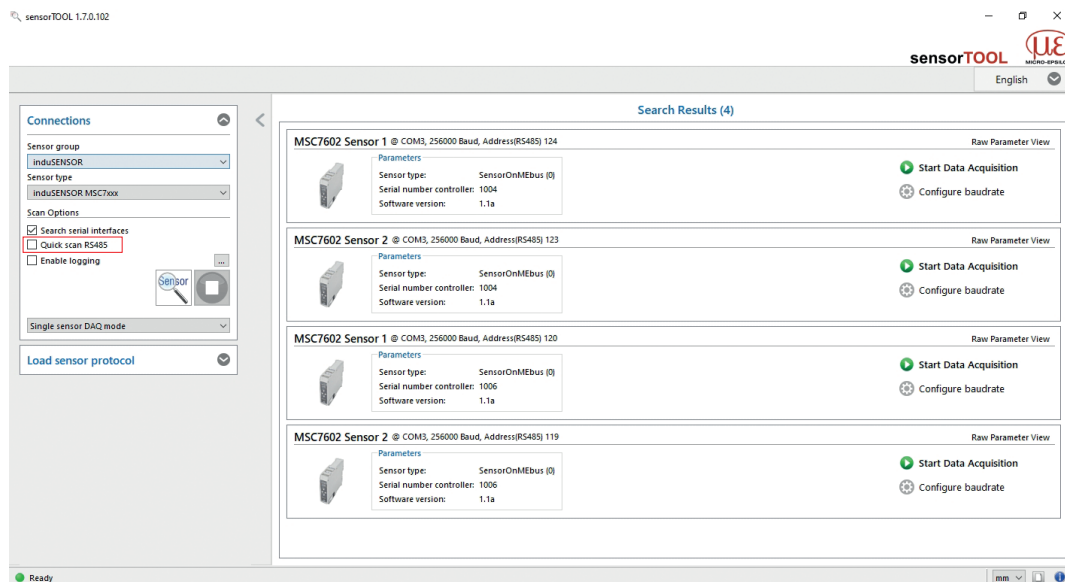


Fig. 87 First interactive site after calling the `sensorTOOL`

- ➡ If not already done, configure each individual channel, see A 3.3 and then return to the first interactive page after calling `sensorTOOL` (Search Results), see Fig. 87.
- ➡ Now enable the Multi sensor DAQ mode.
- ➡ Then enable the individual checkboxes Use sensor in MULTI-DAQ of the respective channels.

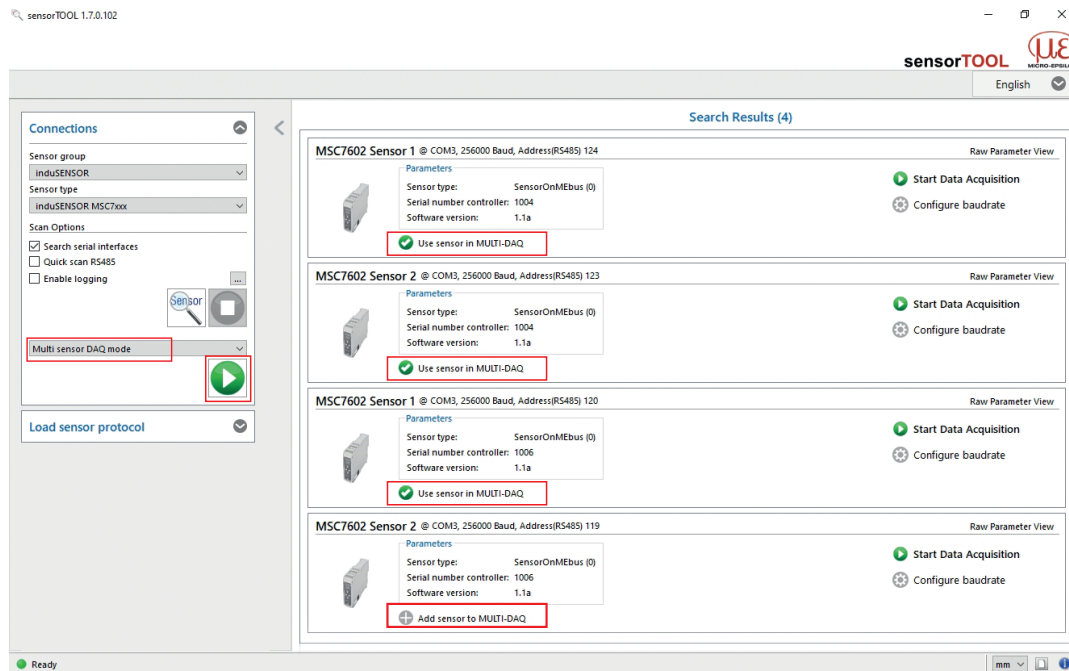



Fig. 88 First interactive site after calling the `sensorTOOL` for the Multi sensor DAQ mode

- ➡ Now press the  button.

In the Data Acquisition menu, see A 3.4, the data output of the selected channels is displayed.

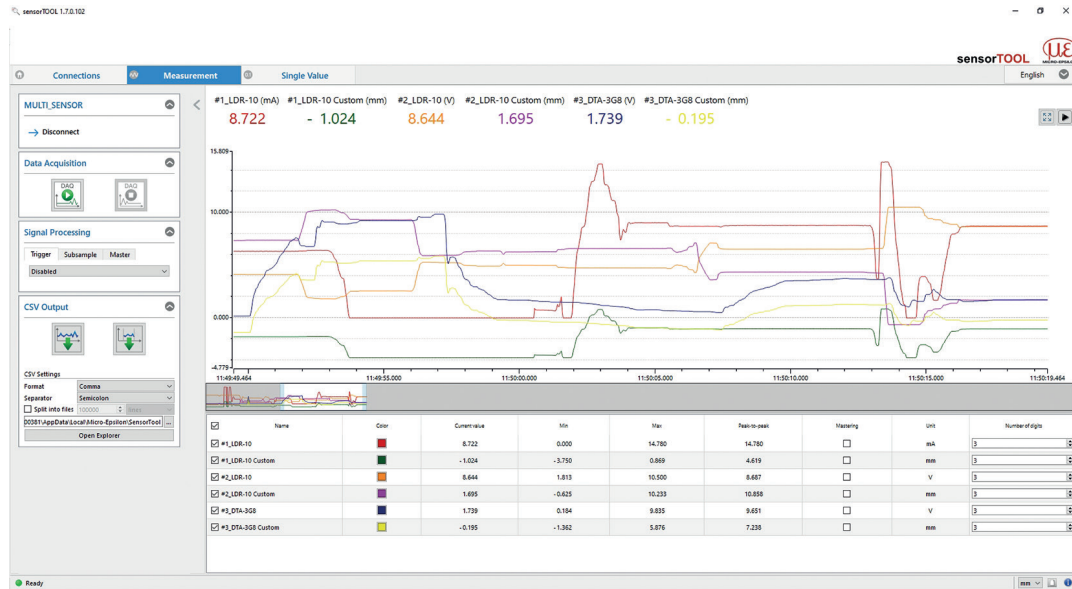


Fig. 89 Data Acquisition menu, Multi sensor DAQ mode

The Single Value, [see A 3.5](#), menu also displays the data as numerical value.

The screenshot shows the sensorTOOL software interface with the 'Single Value' menu selected. The interface is divided into several sections: 'Connections', 'Measurement', and 'Single Value'. The 'Single Value' section displays six numerical values for different sensors, each with a unique color and unit. Below the values is a table listing the sensor names, colors, units, and current values.

Name	Color	Units	Current value	Min	Max	Peak-to-peak	Mastering	Unit	Number of digits
#1_LDR-10	Red	mA	17.132	0.000	20.500	20.500	<input type="checkbox"/>	mA	5
#1_LDR-10 Custom	Green	mm	1.604	-3.750	6.406	6.406	<input type="checkbox"/>	mm	5
#2_LDR-10	Orange	V	4.520	-4.469	10.500	6.031	<input type="checkbox"/>	V	5
#2_LDR-10 Custom	Purple	mm	6.850	-0.625	6.914	7.539	<input type="checkbox"/>	mm	5
#3_DTA-3G8	Blue	V	0.185	0.184	1.728	1.544	<input type="checkbox"/>	V	5
#3_DTA-3G8 Custom	Yellow	mm	-1.361	-1.362	-0.204	1.156	<input type="checkbox"/>	mm	5

Fig. 90 Single value menu, Multi sensor DAQ mode

A 4 Communication via RS485 Digital Interface

A 4.1 General

These instructions tell you how to obtain digital measurement values from the induSENSOR MSC7xxx controller without the MICRO-EPSILON `sensorTOOL`.

The controller must be configured as per these Operating Instructions prior to direct digital communication.

A 4.2 Hardware Configuration

Transmission technology: UART

Electrical level: RS485

Baud rate: 256,000 baud (optional: 9600 baud)

Data framing: Startbits: 1; Databits: 8; Parity: Even; Stopbits: 1

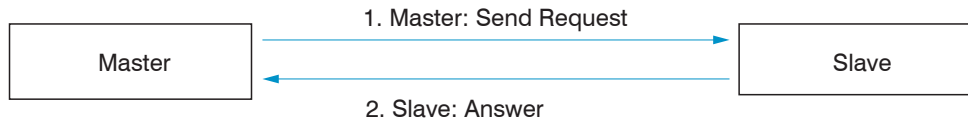


Fig. 91 Hardware configuration

A 4.3 Protocol

Name	Description	Format	Example
DA	Destination Address	1 byte	0x7E = Address: 126
SA	Source Address	1 byte	0x01 = Address: 1
New_Adr	New Address	1 byte	0x7C = Address: 124
FSC	Checksum	Sum without arithmetic overflow; mod 256	

Fig. 92 Protocol example

i DA and SA have to be different!

A 4.4 Commands

A 4.4.1 Identification

Send:	0x68	0x09	0x09	0x68	0x7E ¹	0x01 ²	0x4C	0x30	0x33	0x5E	0x10	0x0	0x4A
	0xE6 ³	0x16											
Receive:	0x68	0x53	0x53	0x68	0x01 ²	0x7E ¹	0x08	0x33	0x30	0x5E	0x10	0x00	0x4A
	0x01	0x00	0x63	0x10	0xA1	0xA7	0x3E	0x00	0x00	0x00	0x00	0x00	0x00
	0x00	0x00	0x00	0xE8	0x03	0x00	0x00	0x00	0x00	0x00	0x00	0x00	0x00
	0x00	0x00	0x00	0x00	0x00	0x00	0x2E	0xB2	0x21	0x00	0x00	0x00	0x00
	0x00	0x4D	0x53	0x43	0x37	0x34	0x30	0x31	0x20	0x20	0x20	0x20	0x20
	0x20	0x20	0x20	0x20	0x20	0x20	0x20	0x20	0x20	0x20	0x20	0x20	0x20
	0x20	0x20	0x20	0x20	0x20	0x20	0x20	0x01	0x16	0x6E ⁴	0x16		
Result:	Description			Format					Example				
	Article number			Bytes 18 - 21: 4 bytes, uint32, little endian					4106145				
	Serial number			Bytes 30 - 33: 4 bytes, uint32, little endian					1000				
	Article description			Bytes 54 - 85: 32 bytes, ASCII					MSC7401				

1) DA: 126

2) SA: 1

3) CH: Checksum Send: Bytes 5 - 13

4) CH: Checksum Receive: Bytes 5 - 87

A 4.4.2 Assign New Address

Send:	0x68	0x09	0x09	0x68	0x7E ¹	0x01 ²	0x43	0x37	0x3E	0x7C ⁵	0x00	0x00	0x00
	0xB3 ³	0x16											
Receive:	0xE5												

Afterwards a reset is necessary. This can be done by sending the reset message or by disconnecting the controller from power supply.

- 1) DA: 126 → 5) DA new: 124
- 2) SA: 1
- 3) CH: Checksum Send: Bytes 5 - 13
- 4) -

A 4.4.3 Reset

Send:	0x68	0x09	0x09	0x68	0x7E ¹	0x01 ²	0x4C	0x30	0x33	0x5E	0xB0	0x00	0x01
	0x3D ³	0x16											
Receive:	0x68	0x0A	0x0A	0x68	0x01 ²	0x7E ¹	0x08	0x33	0x30	0x5E	0xB0	0x00	0x01
	0x02 ⁴	0xFB	0x16										

- 1) DA: 126
- 2) SA: 1
- 3) CH: Checksum Send: Bytes 5 - 13
- 4) CH: Checksum Receive: Bytes 5 - 13

A 4.4.4 Get Measuring Value

Send:	0x10	0x7E ¹	0x01 ²	0x4C	0xCB ³	0x16							
Receive:	0x68	0x0B	0x0B	0x68	0x01 ²	0x7E ¹	0x08	0xAE	0x47	0x61	0x3F	0x00	0x00
	0x00	0x00	0x1C ⁴	0x16									
Result:	Description			Format				Example					
	Unscaled value			Bytes 8 - 11: 4 bytes, float, little endian				0x3F6147AE (float) = 0.88 V					
	Scaled value			Bytes 12 - 15: 4 bytes, float, little endian				If this value is 0, the controller was not set up. Otherwise, the digital counterpart of the analog output will be sent according the setting you have done in the controller before.					
Maximum speed for data transmission (1x send + 1x receive): ~3 ms @ 256.000 Baud													

1) DA: 126

2) SA: 1

3) CH: Checksum Send: Bytes 2 - 4

4) CH: Checksum Receive: Bytes 5 - 15



MICRO-EPSILON MESSTECHNIK GmbH & Co. KG
Koenigbacher Str. 15 · 94496 Ortenburg / Germany
Tel. +49 (0) 8542 / 168-0 · Fax +49 (0) 8542 / 168-90
info@micro-epsilon.com · www.micro-epsilon.com
Your local contact: www.micro-epsilon.com/contact/worldwide/

X9751377-B032062HDR
© MICRO-EPSILON MESSTECHNIK